

# DZMx Plus Installation Manual

Product Revision 4.0



## Section 1: Manual Revisions and Approvals

Revision	Effective Date	Approved By	Reasons for Change
1.1	28 Jun 2021	James Mace Richard Benfield	New issue
1.2	1 Sept 2022	Richard Benfield James Mace	HW-1698
1.3	18 Nov 2022	Richard Benfield James Mace	HW-2247
1.4	15 March 2023	James Mace	HW-2330
1.5	1 October 2023	James Mace	
1.6	23 January 2024	James Mace	Release of DZMx Plus Revision 4.0 and for Firmware Release 4.11.0

Except as expressly provided below, no part of this document may be reproduced, copied, transmitted, disseminated, downloaded, or stored in any storage medium, for any purpose other than that which Flightcell International has provided this document for. Any electronic or printed copy of this document or any revision must contain the complete text of this copyright notice. Any unauthorised commercial distribution of this document or any revision hereto is strictly prohibited.

Information in this document is subject to change. Document users are responsible for ensuring printed copies are valid prior to use.

© Copyright 2024 Flightcell International Ltd – All Rights Reserved

117-00010 Rev 1.6 Flightcell DZMx Plus Installation Manual  
Effective Date: 23 January 2024

# CONTENTS

SECTION 1: MANUAL REVISIONS AND APPROVALS.....	2
SECTION 2: INTRODUCTION .....	4
Applicability of this Manual.....	4
New in Revision 4.0 and Firmware 4.11.0.....	4
SECTION 3: DZMX PLUSEQUIPMENT .....	5
Connectors.....	5
SECTION 4: DZMX PLUS SPECIFICATIONS .....	6
Variants and Part Numbers .....	6
Dimensions .....	6
Electrical .....	7
Environmental/EMI Qualifications.....	8
SECTION 5: INSTALLATION .....	9
Mounting the DZMx Plus.....	9
DZMx Plus Wiring Guide.....	10
Installing a DZMx Plus Control Head.....	16
DZMx Plus Antennas .....	17
SECTION 6: CONFIGURATION .....	19
Accessing Installation and Configuration Settings.....	19
Configuring the DZMx Plus .....	19
Audio Installation and Configuration .....	22
Iridium Push-To-Talk(IrPTT) .....	26
Modem Configuration .....	27
Configuring the cellular bands used by the DZMx Plus cellular modem.....	31
Backlighting.....	32
DZMx Plus Data.....	38
DZMx Plus Wi-Fi .....	40
DZMx Plus Bluetooth™ .....	43
DZMx Plus Messaging.....	45
DZMx Plus Tracking .....	45
DZMx Plus Inputs and Outputs .....	56
Exporting GPS data.....	59
Configuring DZMx Plus Data.....	59
DZMx Data Logging .....	62
DZMx Flight Data Recorder.....	63
Recording and Transmitting Maintenance Data .....	64
Forms.....	68
SECTION 7: DZMX PLUS APPLICATIONS.....	72
DZMx Plus Applications and Licences .....	72
DZMx Plus Applications .....	72
SECTION 8: MAINTENANCE, DIAGNOSTICS AND SUPPORT .....	73
Firmware Upgrades.....	73
Diagnostics.....	74
Flightcell Remote Assistance .....	75
SECTION 9: DOCUMENTATION AND INFORMATION.....	77
Contact Details.....	77
SECTION 10: WARRANTY.....	78
SECTION 11: ABBREVIATIONS.....	79
APPENDIX 1. CONNECTOR KITS SUPPLIED WITH DZMX PLUS AND ASSOCIATED PARTS .....	80
APPENDIX 2. ADVANCED ROUTING FUNCTIONS.....	82
APPENDIX 3. CONFIGURATION OF IRIDIUM CERTUS SERVICE .....	86

## Section 2: Introduction

This manual provides information on the installation and configuration of the DZP\_07-xxx-xxxx Flightcell DZMx Plus.

### Applicability of this Manual

This manual applies to DZP\_07 Flightcell DZMx Plus revision 4.0 with firmware 4.11.0.

### New in Revision 4.0 and Firmware 4.11.0

New features and enhancements are available with Revision 4.0 and firmware 4.11.0.

#### Revision 4.0

##### *Optional Software Defined Receiver (SDR)*

A Software Defined Receiver can be installed as an additional expansion card and provides for reception of a range of different radio transmissions. The SDR card is installed at production.

See next section for additional capabilities provided by the SDR.

#### Firmware 4.11.0

##### *Software Defined Receiver support*

The SDR can receive a wide range of transmissions, including:

- » AM radio - AM mono audio channels
- » FM radio - wide band (200kHz channel bandwidth) mono FM audio reception.
- » NBFM - narrow band (12kHz channel bandwidth) FM mono radio.
- » ADSB-IN 1090 MHz
- » AIS (vessel identification and tracking system) 162 MHz.

Configuration and operation of the SDR and associated applications is provided in a separate manual. Contact Flightcell for this manual and further information.

##### *Advanced routing functions*

Support for enhanced networking on DZMx where more than one IP data capable modem is installed (two cell modems or a Certus modem), including automatic failback.

See *Appendix 2. Advanced routing functions* on page 82

##### *Iridium Certus support*

The DZMx supports an Iridium Certus modem, providing an IP data connection and voice connection over the Iridium Certus service.

Initial support is for the Guardian G6 and G6S mid-band Iridium Certus modems.

See *Appendix 3. Configuration of Iridium Certus service* on page 86.

##### *Enhanced Wi-Fi security*

Enhanced security features have been implemented on the DZMx Wi-Fi service.

See *DZMx Plus Wi-Fi* on page 40.

## Section 3: DZMx Plus Equipment

The DZMx Plus should be inspected when unpacked to check for any visible damage or missing components.

### Connectors

Connector kits are supplied with the DZMx Plus Transceiver DZP\_07-xxx-xxxx and DZMx Plus Control Head, DZP\_05-002.

The content of the connector kits depends on the version of the DZMx Plus. Optional extras based on the unit dash number and customer requirements may be supplied at additional cost.

Details of the connector kit contents for the DZMx Plus and associated parts are provided in Appendix 1.

# Section 4: DZMx Plus Specifications

## Variants and Part Numbers

The DZMx Plus can be built with a range of hardware options.

The DZMx Plus part number is DZP\_07. The 3 - 7 digit dash number immediately following DZP\_07- designates the variant of the DZMx Plus.

The available variants may change from time to time. The options available to build up the different variants are:

- » Installed modems (see "Modem Configuration" on page 24 for a list of supported modems)
- » Additional circuit cards
  - » Second ethernet
  - » ARINC 429
  - » Input expansion card.

## Dimensions

Dimension	DZMx Plus Transceiver Unit	DZMx Plus Control Head DZUS mount
Faceplate Width	N/A	146mm
Extrusion Width	N/A	126mm
Faceplate Height	N/A	57mm
Extrusion Height	N/A	54mm
Depth	N/A	23mm
Weight	1.6kg (depending on configuration)	200 grams
Length	240mm	N/A
Width	58mm	146mm
Height	188mm	57mm

## Electrical

DZMX PLUS TRANSCEIVER UNIT		
Part/Item	Parameter	Value
Power	Input Voltage	12-32VDC
	Power Supply Current	Up to 1.5A @28VDC
ICS to DZM Audio	Input Levels	20mVrms to 1.15Vrms, adjustable
		775mVrms to 1.15RMS nominal
	Input Impedance	600Ω
Microphone bias voltage		12V via 2.2kΩ
DZM to ICS Audio	Output levels	Up to 5Vrms, adjustable
		775mVRMS nominal
	Output Impedance	150Ω
GPS	Antenna bias voltage	5V
	Antenna current	Up to 100mA
	Sensitivity	-162dBm (with Flightcell Antenna)
	Time to first fix	26s
Wi-Fi	Tx power (dBm)	16
	Antenna gain (dBi)	2.0
	Total power (dBm)	18
	Total power (mW)	63.1
Bluetooth	Tx power (dBm)	10
	Antenna gain (dBi)	2.0
	Total power (dBm)	12.0
	Total power (mW)	15.9
Satellite Iridium	RF Frequency Range	1616 MHz to 1625.5 MHz
	Tx power (max)	7W
	Antenna gain (dBi)	3
	RF RX Sensitivity	-118 dBm
	Max Cable Loss	3 dB
	Antenna impedance	50 Ω
USER INTERFACE		
Power switch	Momentary action switch PWR on/off with backlight	
LEDs	Transceiver Status Indicator x3	

DZMx PLUS CONTROL HEAD SPECIFICATION		
Part/Item	Parameter	Value
Power	Input Voltage	12-32VDC
	Supply Current	Up to 1A @ 28VDC
Data connection	RS485 full duplex	Serial data interface between Control Head and DZMx Plus
Backlighting	Input Control	User-configurable fixed level or controlled from an external lighting dimmer. 0-28VDC or user-configurable response
	Colour	Green 540nm. Designed for NVIS B compliance
USER INTERFACE		
Keypad	16 Button Keypad	
LCD Display	LCD backlit monochrome	

## Environmental/EMI Qualifications

The DZMx Plus is designed against RTCA DO-160G.

Details of the DO-160G compliance is provided in the DZMx Plus Declaration of Design and Performance (DDP) (document 120-00003 DZP\_07 DZMx Plus DDP).

DO-160G test reports are available on request from [tech@flightcell.com](mailto:tech@flightcell.com).



# Section 5: Installation

## Mounting the DZMx Plus

The DZMx Plus is comprised of the Transceiver Unit and the Control Head.

The DZMx Plus Transceiver Unit is designed to be installed in an ARINC 600 2MCU tray, Flightcell part number MEP\_01-000

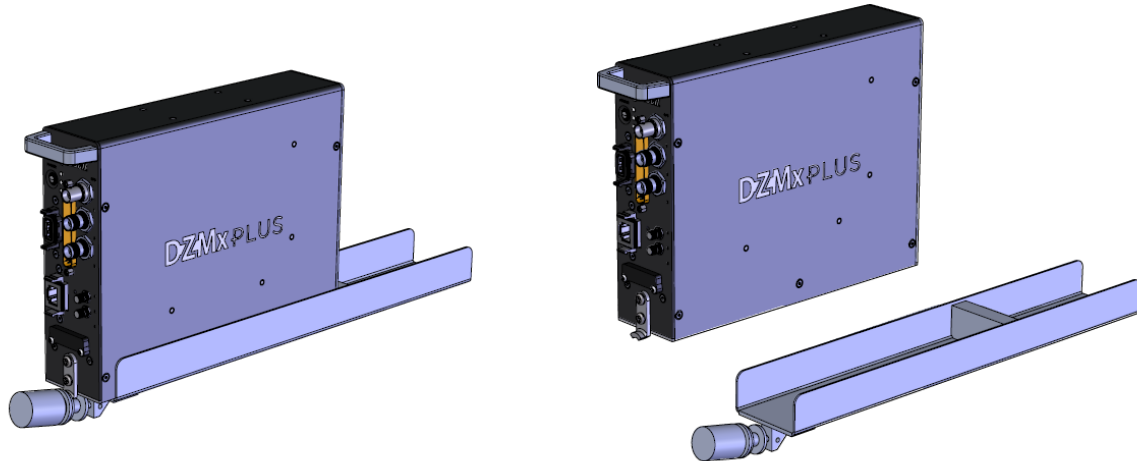

*DZMx Plus Mechanical Assembly ARINC 600 2MCU Tray*

The DZMx Plus Control Head is designed to be installed in DZUS rails.

Mechanical drawings for the DZMx Plus Control Head, Transceiver Unit and mounting tray showing dimensions and mounting details are provided on the Flightcell website [www.flightcell.com/resources](http://www.flightcell.com/resources).

CAD solid model files are available on request from Flightcell International. Contact [tech@flightcell.com](mailto:tech@flightcell.com).

### Mounting options when replacing original satcom systems with the DZMx Plus

Versions of the DZMx Plus Transceiver Unit may be available to install in the mounting tray for previously installed systems, such as Skyconnect.

Please contact Flightcell International for part numbers and drawings for these options.

### Mounting the DZMx Plus Control Head

The DZMx Plus Control Head should be mounted where the flight crew or radio operator have a clear view of the display and can easily use the keypad.

If the DZMx Plus Control Head is installed in the pedestal, for ease of use, it is preferable to install it as near to the front of the pedestal as possible.

The DZMx Plus LCD is designed for optimum readability when viewed at angles between 60° above the display to 20° below. Avoid mounting the unit where the display will be viewed at an oblique angle, as it may not be clearly readable. It is preferable to mount the DZMx Plus to minimise sunlight shining on the display.

## DZMx Plus Wiring Guide

Wiring diagrams for the Flightcell DZMx Plus and associated equipment are available on the Flightcell website at [www.flightcell.com/resources](http://www.flightcell.com/resources)

### Necessary Installations

The following are essential parts of the DZMx Plus installation:

- » Power Supply
- » DZMx Plus Antennas
- » SIM Cards

### Power Supply

The DZMx Plus unit and other components require aircraft DC power. Operating range is 12-32VDC. It is recommended that the DZMx Plus be connected to the emergency (primary) power bus on the aircraft. This is to ensure successful operation of tracking (including engine start/stop data) and emergency calls.

When operating on a nominal 28V supply circuit breakers or fuses of the following rating should be used between DZMx Plus system components and the power supply:

- » A 4-amp circuit breaker/fuse is recommended for the DZMx Plus system
- » A 1-amp circuit breaker/fuse is recommended for an external modem (Iridium or cellular) module, if installed
- » A 1-amp circuit breaker/fuse is recommended for a Flightcell Iridium phone cradle, if installed
- » A 1-amp circuit breaker/fuse is recommended for the DZMx Plus Control Head

If combining two or more circuits on a single circuit breaker a 4-amp circuit breaker/fuse is recommended.

### Fabricating Wiring Harnesses

All wiring should be carried out with aviation specification fireproof cable.

Screened cable should be used where indicated in the wiring diagrams. Where cable screen connections are not explicitly shown, they should be left unterminated.

The following minimum wiring specification is recommended:

- » **Power supply** - 22 AWG stranded (0.325mm<sup>2</sup>)
- » **Other cabling** - 24 AWG stranded (0.205mm<sup>2</sup>).

It is recommended that enough slack be left in the main cable to enable the DZMx Plus to be partially removed from the aircraft panel for service or to exchange the Iridium and/or cellular SIM card.

### Grounding and Shielding Terminations

The DZMx Plus Transceiver chassis ground connection is on the Transceiver Unit's primary connector. It does not have a DZUS connection.

If the DZMx Plus Control Head is mounted in a DZUS rack, the housing is grounded to the DZUS rails via the DZUS connectors and contact between the front panel metalwork and the DZUS rails.

## Installing Data Ports

The DZMx Plus has several data connections wired off the main connector:

- » RS232 - used as a debug port or for serial data connections to:
  - » A Flightcell Iridium phone cradle
  - » A Flightcell Iridium satellite modem
  - » Other external data sources such as water tank controllers.
- » RS422/RS485 - used for serial data connections, and connection to one or more DZMx Plus Control Heads.
- » Two additional data connections are available as options, and these are wired off the main connector
  - » ARINC429 - used to send and receive over the aircraft ARINC429 data bus.
  - » Second Ethernet - used to provide a second ethernet connection.

## Connector Pinouts

Wiring diagrams for the Flightcell DZMx Plus Transceiver and DZMx Plus Control Head are available on the Flightcell website [www.flightcell.com/resources](http://www.flightcell.com/resources)

Refer to the figure below for the layout of the DZMx Plus Transceiver front plate.

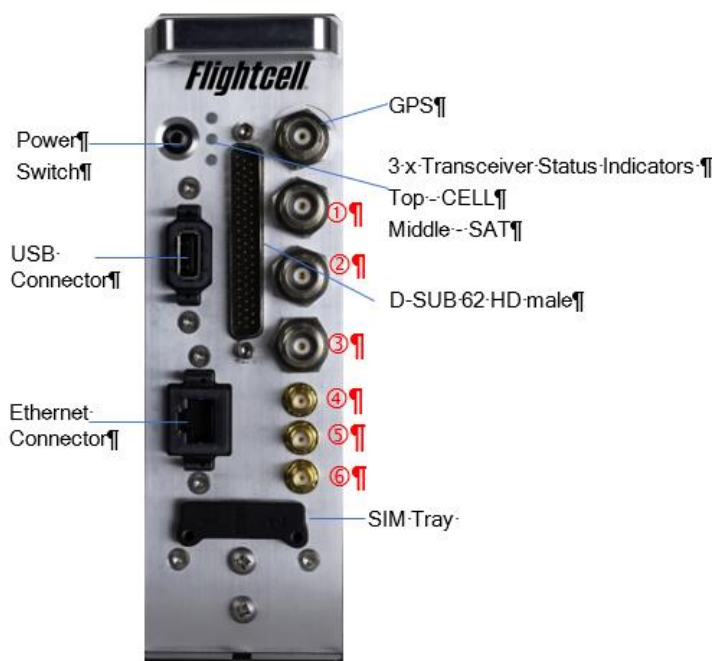

CONNECTORS	
Main Connector:	D-SUB 62 HD male
	Ethernet
	USB
Antenna Connectors:	GPS: BNC
	① SAT: TNC
	② CELL:TNC
	③ SAT:TNC
	④ Wi-Fi: SMA
	⑤ Bluetooth: SMA
	⑥ Special purpose transceiver: SMA
OTHER	
Power switch	Momentary Action PWR On/Off
LEDs	Transceiver Status Indicator x3
	GREEN - Good Signal
	AMBER - Medium Signal
	RED - Bad Signal
	OFF - No Signal
SIM TRAY	Transceivers 1 and 2

















DZMx Plus Main Connector D-SUB62			
Pin No	Connector	Direction	Notes
1	POWER GROUND	Ground	
2	AUDIO FROM DZM2 HI	Output	HI audio output to ICS 2
3	AUDIO FROM DZM2 LO	Output	LO audio output to ICS 2
4	AUDIO FROM DZM1 HI	Output	HI audio output to ICS 1
5	AUDIO FROM DZM1 LO	Output	LO audio output to ICS 1
6	NC		
7	RS485 Rx+	Input	
8	USB ID OTG	I/O	
9	AUX DATA GND	Ground	
10	GND	Ground	
11	GND	Ground	
12	RH_KEY	Input	
13	SPARE SHIELD	Ground	
14	POWER GROUND	Ground	

DZMx Plus Main Connector D-SUB62			
Pin No	Connector	Direction	Notes
15	OUTPUT 1A	Output	Isolated output 1 Terminal A
16	OUTPUT 1B	Output	Isolated output 1 Terminal B
17	OUTPUT 2A	Output	Isolated output 2 Terminal A
18	OUTPUT 2B	Output	Isolated output 2 Terminal B
19	NC		
20	GENERAL PURPOSE INPUT 1	Input	
21	DC SUPPLY POSITIVE	Power	
22	POWER GROUND	Ground	
23	USB GND OTG	Ground	
24	USB D+ OTG	I/O	
25	USB VBUS OTG	Power	
26	AUDIO TO AUX TXCVR HI	Output	
27	AUDIO TO AUX TXCVR LO	Output	
28	NC		
29	RS485 Rx-	Input	
30	SPARE SHIELD	Ground	
31	POWER GROUND	Ground	
32	SPARE SHIELD	Ground	
33	GPIO1	I/O	Reserved for Optional Capabilities
34	GPIO2	I/O	Reserved for Optional Capabilities
35	POWER GROUND	Ground	
36	POWER GROUND	Ground	
37	AUX DATA OUT	Output	
38	MIC TO DZMx Plus 2 HI	Input	Unbiased/biased (configurable)
39	MIC TO DZMx Plus 2 LO	Input	Return for audio input from ICS 2
40	GPIO5	I/O	Reserved for Optional Capabilities
41	GPIO6	I/O	Reserved for Optional Capabilities
42	DC SUPPLY POSITIVE	Power	
43	CHASSIS GND	Ground	Internally connected to DZMx Plus Chassis
44	USB D- OTG	I/O	
45	AUDIO FROM AUX TXCVR HI	Input	
46	AUDIO FROM AUX TXCVR LO	Input	
47	MIC TO DZMx Plus 1 HI	Input	Unbiased/biased (configurable)
48	RS485 Tx+	Output	

DZMx Plus Main Connector D-SUB62			
Pin No	Connector	Direction	Notes
49	MIC TO DZMx Plus 1 LO	Input	Return for audio input from ICS 1
50	RS485 Tx-	Output	
51	AUX DATA IN	Input	
52	NC		
53	GPIO3	I/O	Reserved for Optional Capabilities
54	GPIO4	I/O	Reserved for Optional Capabilities
55	GPIO9	I/O	Reserved for Optional Capabilities
56	GPIO8	I/O	Reserved for Optional Capabilities
57	GPIO7	I/O	Reserved for Optional Capabilities
58	GENERAL PURPOSE INPUT 5	Input	
59	GENERAL PURPOSE INPUT 4	Input	
60	GENERAL PURPOSE INPUT 3	Input	
61	GENERAL PURPOSE INPUT 2	Input	
62	DC SUPPLY POSITIVE	Power	
D62 shell	CHASSIS GND	Ground	

## DZMx Plus Keypad References

Most keys on the DZMx Plus Control Head keypad have more than one function. The following table outlines how the DZMx Plus Control Head keys are referenced throughout the Installation Manual.

Icon	Manual Reference	Icon	Manual Reference
	CALL		5, SPD2
	END		6, RIGHT, SPD3
	A		7, MSG
	B		8, DOWN, DIR
	1, MARK		9, MODE
	2, UP, A.R.M., ALERT		0, +, MENU
	3, EMER		*, BACK
	4, LEFT, SPD1		#, ENTER, POWER

## Navigating the Menus

The keypad is used to access the menu system:

- » Press *MENU*. If the DZMx Plus is on a phone call, press and hold *MENU* to access the menus.
- » Use the *UP* and *DOWN* arrow keys to navigate between the menu options.
- » Use the *LEFT* and *RIGHT* arrow keys to scroll left or right, to increase, decrease or navigate menus.
- » Press *ENTER* to select the highlighted item or to confirm a setting change.
- » Press *BACK* to cancel a setting or to move back a menu level.
- » Press *END* to cancel a setting change or to exit the menu and return to the main screen.

Instructions will be provided throughout the Manual in the format *MENU > Forms >Form Entry* etc

The **>** indicates that you will need to scroll to a menu heading using the arrow keys.

Menu headings are bolded. Select a heading, press the *ENTER* key then scroll to the next menu heading.

## Installing a DZMx Plus Control Head

A Flightcell DZMx Plus Control Head is a remotely located control panel for the DZMx Plus, with a display and keypad.

One or two Flightcell DZMx Remote Heads may be installed to provide other crew or mission specialists with full remote control of the DZMx Plus.

## Wiring the Control Head and Remote Heads

The Control Head and Remote Heads connect to the DZMx Plus Transceiver Unit RS485 serial data connection.

The RS485 data pins on the Control Head and Remote Heads are connected to common pins on the Transceiver Unit.

Remote Head Key can be paralleled with all remote heads for Power On to the DZMx Plus.

DZMx Plus	Control Head	Remote Head	Remote Head
RS485 TX+ PIN 48	RS485 RX+ PIN 12	RS485 RX+ PIN 12	RS485 RX+ PIN 12
RS485 TX- PIN 50	RS485 RX- PIN 4	RS485 RX- PIN 4	RS485 RX- PIN 4
RS485 RX+ PIN 7	RS485 TX+ PIN 3	RS485 TX+ PIN 3	RS485 TX+ PIN 3
RS485 RX- PIN 29	RS485 TX- PIN 11	RS485 TX- PIN 11	RS485 TX- PIN 11
RH_KEY- PIN 12	OUTPUT 1B- PIN 6	OUTPUT 1B- PIN 6	OUTPUT 1B- PIN 6

An R1=120R termination resistor should be connected to the Rx pair of the main RS485 cable (refer to wiring diagram).

The heads require an independent connection to a 12-32VDC power supply, and a chassis ground.

Backlighting of the Control Heads can be configured individually, or each of the heads can be connected to a cockpit lighting controller if required.

Wiring diagrams for the Flightcell DZMx Plus Transceiver Unit and DZMx Plus Control Head are available on the Flightcell website at [www.flightcell.com/resources](http://www.flightcell.com/resources).

Wi-Fi and Bluetooth antennas in the DZMx Plus Control Head are identical, so the antenna cables can be connected to either connector.

## Configuring the DZMx Plus for one or two Remote Heads

The primary Control head is pre-configured to correctly communicate with the DZMx Plus with its Head Address set to A. Additional Remote Heads need to be activated in the DZMx Plus so they are correctly recognised.



- » Press *MENU* > *Hardware Config* > *Head B/C Enable*. Select *On* to enable, or *Off* to disable.
- » Press *ENTER* to save the setting.

## Configuring the Remote Heads

Each Remote Head needs to be allocated a unique head ID so that the DZMx Plus can identify it.

- » Press and hold the *BACK* key on the Head for 2 seconds, then release. Scroll down to *Advanced* press *ENTER*.
- » *Head ID <A>* will be displayed. Use the *RIGHT* and *LEFT* arrow keys to select the correct head ID (Head B/C), then press the *END* key twice to save and return to the main screen.

## DZMx Plus Antennas

The following antennas are not supplied with the DZMx Plus but can be purchased at an extra cost:

- » Single Iridium modem: Use a Flightcell dual Iridium/GPS antenna part number: ANP\_00043.
- » Dual Iridium modems: Use a Flightcell Iridium/GPS antenna, P/N ANP\_00043, and a single Iridium antenna, ANP\_00045.
- » Single cellular modem: Use a Flightcell cellular antenna, P/N ANP\_00033.
- » Dual cellular modems: Use a Flightcell dual cellular antenna, P/N ANP\_00041.

## Installation of Iridium and GPS Antennas

Specification drawings for the above antennas are available on the Flightcell website [www.flightcell.com/resources](http://www.flightcell.com/resources). It is the responsibility of the installer to obtain the correct certification to install antennas on the airframe.

The Flightcell Iridium/GPS antenna and Iridium antenna should be installed on the top of the aircraft where they will have an unrestricted view of the sky, mounted as close to horizontal as possible. The following should be considered when determining a mounting location:

- » Maintain good separation from other antennas. Preferred separation is 750mm from L-band (GPS), TCAS or transponder antennas, but a lesser separation can be applied if there is limited space on the aircraft.
- » On a helicopter, the antenna can be installed below the rotor blades, but avoid installing it close to the rotor hub, as the hub and inner rotor can block the antenna's view of the sky.
- » Keep coax cable lengths short to minimize attenuation of transmit and receive signals.

## Installation of Cellular Antennas

A Flightcell cellular antenna should preferably be installed on the underside of the aircraft to provide best connection to the cellular network. Typical location is below the cockpit to minimise antenna cable length. The minimum recommended separation between the cell antenna and other antennas is 600mm.

## Guidelines for Antenna Cables

Iridium antenna cables must be selected to keep signal loss within accepted levels. Total signal loss on the Iridium connection between the DZMx Plus or Iridium phone cradle and the antenna should not exceed 3dB at 1645MHz.

The maximum recommended length for different common antenna cable types is:

Cable Length	Cable Specification
Up to 3m	RG58C/U or RG400
Up to 6.5m	LMR200 or RG142A/U-9006 cellfoil
Up to 8m	RG213
Up to 17m	LMR400
Up to 26m	LMR600

Antenna connectors on the DZMx Plus and Flightcell antennas (as well as the supplied mating connectors) are colour coded to reduce installation errors, as follows:

Antenna Type	Colour
Iridium	Red
Cellular	Green
GPS	Blue

# Section 6: Configuration

## Accessing Installation and Configuration Settings

Many of the DZMx Plus configuration settings are hidden during normal operation. To access these settings, the Installer Menu needs to be activated. The Installer Menu will remain active until the DZMx Plus is next powered off. If a menu item mentioned in this manual cannot be found ensure that the Installer Menu has been activated.

## Configuring the DZMx Plus

The DZMx Plus can be configured using the DZMx Plus keypad and display or using DZMx Connect. Most settings are available on both interfaces.

















It is recommended that DZMx Connect is used to configure and to change settings as it is faster and provides a more intuitive interface than the DZMx Plus keypad.

However, it is useful to use the DZMx Plus keypad when real-time feedback on the configuration is preferred:

- » Adjusting audio settings.
- » Configuring the general purpose inputs.

## Configuration using the DZMx Plus Keypad

Most keys on the DZMx Plus keypad have more than one function. The following table outlines how the DZMx Plus keys are referenced throughout the manual.

Icon	Manual Reference	Icon	Manual Reference
	CALL		5, SPD2
	END		6, RIGHT, SPD3
	A		7, MSG
	B		8, DOWN, DIR
	1, MARK		9, MODE
	2, UP, A.R.M., ALERT		0, +, MENU
	3, EMER		*, BACK
	4, LEFT, SPD1		#, ENTER, POWER

## Navigating the Menus

To access the menu system:

- » Press *MENU*. If the DZMx Plus is on a phone call, press and hold *MENU* to access the menus.
- » Use the *UP* and *DOWN* arrow keys to navigate between the menu options.
- » Use the *LEFT* and *RIGHT* arrow keys to scroll left or right, to increase, decrease or navigate menus.
- » Press *ENTER* to select the highlighted item or to confirm a setting change.
- » Press *BACK* to cancel a setting or to move back a menu level.
- » Press *END* to cancel a setting change or to exit the menu and return to the main screen.

Instructions will be provided throughout the Manual in the format *MENU > Forms > Form Entry* etc.

The > indicates that you will need to select *ENTER* and scroll to a menu heading using the arrow keys.

## Configuring using DZMx Connect

The DZMx Connect application can be used to configure the DZMx Plus, change settings and edit the DZMx Plus phonebook and Quick Message Library, as well as to access a number of other DZMx Plus functions.

DZMx Connect is available as an iOS application (available from the Apple app store), or as a browser application on a smart device (including Android smartphones) or PC.

There are three ways to use DZMx Connect:

### Hardwired Computer Connection

- » Connect a computer to the DZMx Plus Ethernet port.
- » Power up the DZMx Plus and wait for it to fully initialise.
- » Open a web browser, type 192.168.4.1 in the address bar and press *ENTER*. The home screen of DZMx Connect will open in the browser.

If the DZMx Plus has been allocated a fixed IP address, or the DZMx Plus is set up as a DHCP client, then it is necessary to enter this address (this could be, for example, 192.168.4.100).

This IP address can be determined by selecting *MENU > Diagnostics Menu > About DZMx Plus*.

### Wireless Laptop Connection

- » Check that Wi-Fi is enabled. Look for a Wi-Fi icon  located at the top right-hand side of the DZMx Plus display. If the Wi-Fi icon is not present it can be checked and enabled in one of three ways:
  - » Press and hold the MODE key until “Enabling Wi-Fi” is displayed on the display. Wi-Fi can also be disabled with a subsequent press of the MODE key.
  - » Using the DZMx Plus keypad, go to *MENU > Hardware Config > Wireless and Networks > Wi-Fi Enable*. Connect a PC or laptop to the DZMx Plus via an Ethernet cable.

- » Type 192.168.2.1 into a web browser and navigate to *Connectivity > Wi-Fi* and toggle the switch to *ON*.
- » To connect via Wi-Fi,
  - » Open Wi-Fi settings on the laptop, select the Wi-Fi address for the DZMx Plus, then enter the password (the default password is *flightcell*).
  - » Open a web browser on the laptop and type in 192.168.2.1 then press *ENTER*, the home screen of DZMx Connect will open within the browser.

### *Smart Device Connection*

- » If using an iPad or iPhone, download the DZMx Connect app from the Apple app store
- » Connect the smart device to the DZMx Wi-Fi:
  - » Default SSID: *DZMx Wi-Fi*
  - » Default password: *flightcell* (all lower case)
- » On an iPad or iPhone, open the DZMx Connect app
- » On any other device, open a browser and type in 192.168.2.1
- » The initial screen is a discovery screen and the DZMx should be discovered automatically. The **DISCOVER** button is only required if the process needs to be repeated.
- » If the DZMx Wi-Fi IP address has been manually configured, it will be necessary to enter the IP address manually. Click **Manual Entry** and enter the IP address. After the first use of a custom IP address, the app will remember the address in the **Stored Devices** list.
- » Click on the discovered DZMx unit to open DZMx Connect.

To watch a short video explaining DZMx Connect capabilities [Click here](#) (demonstrated on the iOS app).

### **Permission levels**

Permission levels allow control over how the DZMx Plus is configured. Three levels or roles with individually configurable passwords are available within DZMx Connect.

To access Permissions using DZMx Connect:

- » Select **LOGIN**  at the top of the screen. The login screen will open.
- » Select **Installer** or **Administrator** from the dropdown list to the right of Authenticate as:
- » Enter the related **PIN** number from the list below.

Role	PIN number	Responsibility
Installer	2468	The installer can edit all settings and hardware options.
Administrator	2580	An administrator can access all application features and configuration, but is unable to access hardware configurations.

### *To Access Installer Menus Using DZMx Plus Keypad*

- » Go to *MENU > Hardware Config > Installer Menu Enable*, press **ENTER**
- » Enter the **Installer Password** and press **ENTER**. The default Password is **2468**.

### *Changing the Installer Password*

The installer password can be changed as required:

- » On the DZMx Plus control head, go to *MENU > Hardware Config > Change Installer Passwd*
- » On DZMx Connect, go to *Settings > Preferences > Access Management*.

**Note:** It is important to record the password. If the password is forgotten, it will be necessary to reset the DZMx factory settings before the password protected functions can be used again

## Audio Installation and Configuration

The DZMx Plus supports the following audio services:

- » Telephony over the Iridium and cellular networks (depending on the modems installed in the DZMx Plus).
- » Iridium PTT, a Push-to-Talk service using the Iridium network to provide one-to-many PTT calling (IrPTT).
- » Telephony over a mobile phone connected to the DZMx Plus Bluetooth service.

### Configuring DZMx Plus Audio

To configure DZMx Plus audio:

- » On the DZMx Plus keypad, go to *MENU > Audio*
- » On DZMx Connect, go to *Settings > Audio*.

### Connection to the Aircraft Audio System

Audio from the above services is connected into the aircraft audio system or intercom (ICS) to enable aircrew, mission crew or passengers to use these connections.

The DZMx Plus can be connected to the aircraft audio system or ICS in several ways, depending on the aircraft configuration and type of operation.

It is recommended that audio from the DZMx Plus is connected to spare radio positions on the ICS if possible.

Modem connections to the ICS are configured using DZMx Connect. Go to *Settings > Audio > Modems*.

## Single or Dual ICS Connections

The DZMx Plus supports one or two connections to the audio panel/ICS, ICS1 and ICS2.

The dual ICS connections may be used to allow the DZMx Plus to be connected to two different audio panels on the aircraft, or to allow different audio connections to be used simultaneously.

### *Mirroring audio on dual ICS connections*

If the DZMx Plus has connections to two audio panels but it is desirable to have the same audio mirrored to both, select *Mirror Audio to ICS2*. Toggle slider to activate and select DONE.

### *Providing for Modems to be Connected to Separate ICS Connections*

The two ICS connections may be used to allow the DZMx Plus modems or connected Bluetooth device to connect to separate ICS channels, allowing separate calls to occur on the separate respective ICS channels.

Typically, this is used where ICS1 and ICS2 are connected to different audio positions on the ICS.

Each of the modems and Bluetooth device may be allocated to either ICS1 or ICS2.

### *Dual Calling*

The DZMx Plus can make two calls simultaneously:

- » If the two ICS connections are wired, separate calls on ICS1 and ICS2.
- » If only ICS1 is wired to the audio system, two calls on the single ICS channel.

### *Call Priority*

A modem which has been given priority will automatically mute all other calls when it makes or receives a call. When a priority call has ended, it automatically unmutes any other call. This can be particularly useful if a call on a modem is vital to vehicle aircraft operations. By default, call priority is off, however it can be enabled using the "*Call Priority*" setting for each modem in DZMx Connect. Go to *Settings > Audio > Modems*. This option can be found in the settings under the audio section. This setting is particularly useful for simultaneous calls on a single ICS channel.

## Audio from the DZMx Plus to the ICS

Audio from the DZMx Plus is connected direct to the ICS input, and its levels adjusted using the DZMx Plus audio menu.

## Audio from the ICS to the DZMx Plus (microphone installation)

The DZMx Plus can be installed in aircraft systems with either high impedance or low impedance microphones. Most (but not all) civil aircraft operate high impedance (electret) microphone systems. Most (but not all) military aircraft operate low impedance microphone systems. Refer to [www.flightcell.com/resources](http://www.flightcell.com/resources) for wiring diagrams for the microphone connections.

### *Low Impedance Microphones*

When installing the DZMx Plus with an ICS that uses low impedance mics, the DZMx Plus must be connected to a line level Radio/Comms port. If a line-level port is not available and the DZMx Plus is to be connected direct to the mic line, then a tactical radio adaptor will be needed to match impedances. Options include the NAT AA34-300, Jupiter JA34-001 or PS Engineering 200-002-0002.

### *High Impedance Microphones*

There are several options for connecting the DZMx Plus into an audio panel/ICS with high impedance microphones. The way in which the DZMx Plus is connected will depend on your system configuration and operational requirements.

As the Iridium satellite phone and cell phone are both full duplex, it is preferable to use the DZMx Plus on a hot mic connection, rather than PTT (keyed). The DZMx Plus will typically be installed in one of the following ways:

- » Connecting Directly to a Headset Microphone Line.
- » The MIC lines are spliced to one or more headset microphone inputs on the audio panel. As these microphone inputs have mic bias provided by the audio panel, the DZMx Plus should have mic bias disabled.
- » The way this is configured will depend on how many headsets are to have access to the DZMx Plus.
  - » If only the pilot is to use the DZMx Plus, its MIC TO DZMx Plus 1 HI/LO lines are connected only to the pilot's microphone line.
  - » If both pilot and co-pilot are to use the DZMx Plus, the MIC lines are connected to the pilot microphone line and the MIC lines are connected to the co-pilot microphone line.
  - » If more than two microphones need to have access to the DZMx Plus, an external switch is required to select the active microphone input.
- » Connecting to a Cell Phone Port on the Audio Panel. The DZMx Plus MIC line can be connected to the cell phone port on the audio panel.
- » Connecting to a Spare Radio Position on the Audio Panel.
- » On aircraft with separate audio control heads at each crew position, this option enables crew to use the DZMx Plus and connected phones individually on demand. In this case it may be necessary to provide mic bias.

### *Configuring Microphone Bias*

In some aircraft with high impedance headsets, where the mic line is connected direct to the DZMx Plus, it is necessary to provide bias power to energise the headset microphone.

To activate mic bias power to the MIC line:

- » On the DZMx Plus Control Head, go to *MENU > Audio > ICS > Mic Bias*.
- » On DZMx Connect., go to Settings > Audio > ICS1 or ICS2.



### Configuring Side Tone

Side tone is normally provided by the aircraft audio panel or ICS, but in some installations may not be available. Side tone can be supplied by the DZMx Plus if required.

This can be configured using the:

- » On the DZMx Plus Control Head, go to *MENU > Audio > ICS > Mic Bias*.
- » On DZMx Connect, go to Settings > Audio > ICS1 or ICS2.

Select *Off* to disable side tone, *When on Call* to enable only during a call, or *Always On* to leave active all the time.

### Configuring Notification Tones

Notification tones are used to notify the crew of specific events. Notification tones can be enabled or disabled in the audio menu. Notification tones include:

- » Keypad tones.
- » Message queue full, which sounds when the tracking message queue is full.
- » Warnings, which notify when there is an issue; in this case a popup will show the details of the issue.
- » Incoming or outgoing Bluetooth call.

### Configuring ring tones

The DZMx provides ring tones on incoming and outgoing calls.

Some operators find the incoming tone obtrusive or distracting, and prefer to install a separate call annunciator. The ring tone for incoming calls can be suppressed by going to *Settings > Audio > Tones > Incoming Ring Tone* and toggling to **Off**.

**Note:** A call annunciator can be configured to announce incoming calls. See *DZMx Plus Outputs* on page 58 for details on wiring and configuring a call annunciator.

## Adjusting Audio Volume

Audio levels can be adjusted on DZMx Connect or the DZMx Plus Control head, however as there is a short lag when using DZMx Connect, it is recommended that audio levels are adjusted using the DZMx Plus Control head.

To adjust audio volumes to the ICS (EAR):

- » Set up a call to another party over the satellite or cellular link as appropriate
- » Select *MENU > Audio > ICS > Ear*
- » Use the *LEFT* and *RIGHT* keys to adjust the audio volume to the preferred level.
- » Select *END* to save and return to the main screen.

To adjust audio volumes from the ICS to the DZMx Plus (MIC):

- » Set up a call to another party over the satellite or cellular link as appropriate.

- » Go to *MENU > Audio > ICS > Mic* and use the *LEFT* and *RIGHT* keys to adjust the audio volume to the preferred level.
- » Select *END* to save and return to the main screen.

## Iridium Push-To-Talk (IrPTT)

Iridium PTT is a licensed feature.

If you wish to use IrPTT, it is necessary to

- » Subscribe to the IrPTT service through your Iridium Service Provider
- » Purchase an Iridium PTT licence from Flightcell to activate the IrPTT service.

### *Configuring the DZMx for IrPTT*

To enable and configure your DZMx for IrPTT using DZMx Connect, go to *Settings > Modem > Internal Sat modems* and select **PTT Enable**.

If you wish to have the DZMx start up in IrPTT mode, select **Start PTT on Boot**.

### *Configuring the IrPTT Input*

When operating in IrPTT mode, transmissions must be triggered, in one of three ways:

- » Using the pilot's radio PTT switch (the preferred option).
- » A dedicated remote mounted IrPTT switch
- » If a PTT switch is not configured, from the DZMx keypad

### *Configuring the audio panel and DZMx to trigger an IrPTT transmission*

If using IrPTT, the DZMx should be connected to a spare transceiver position. The PTT keyline for that transceiver position is then wired to one of the DZMx General Purpose Inputs - see *DZMx Plus Inputs* on Page 57 for details of how to wire and configure the Input.

If a spare transceiver position is not available, then a vacant receiver position for audio can be used and a separate PTT switch should be installed to trigger IrPTT transmissions.

**Note:** The Call Priority setting can be useful for automatically muting a IrPTT call when making a call on another modem.

## Advanced Audio Settings

DZMx Connect contains a powerful audio panel which enables audio quality from the DZMx Plus to the aircraft audio panel/ICS can be adjusted.

Go to Audio Manager.

## Modem Configuration

The DZMx Plus can be configured with up to three internal modems and one external modem or satellite phone.

### Cellular Modems

The following cellular modems may be installed in the DZMx Plus:

- » A 4G (LTE) modem
- » A 450 MHz modem.

Different countries or geographic areas use different cellular bands, due to international and national radio frequency licensing agreements.

In the DZMx Plus, three different modem versions are used for different geographic regions. The three modem options are:

- » EMEA (Europe, Middle East, Africa)
- » APAC (Asia/Pacific and South America)
- » Americas and Band 14 (North America, including the US Public Safety Band, band 14).

There is considerable overlap in the bands offered by the different modem versions, so some modems can be used in more than one geographic area, with some reduction in the bands available.

When ordering the DZMx Plus, it is essential that the version with the correct regional modem is ordered. Please contact [tech@flightcell.com](mailto:tech@flightcell.com) for more information on the appropriate modem for your operational area.

### Iridium Modems

#### *Internal modems*

The following satellite modems may be installed in the DZMx Plus:

- » One or two internal Flightcell Iridium 9523 narrowband modems; this modem provides voice, tracking and short burst data services
- » An Iridium 9603 modem (used for Short Burst Data only).

#### *External Modems and Phones*

One external modem or satellite phone can be connected to the DZMx Plus via its RS232 serial port:

- » A Flightcell Iridium Modem
- » An Iridium handset installed in a Flightcell Iridium Phone Cradle; these may be:
  - » Iridium 9505A
  - » Iridium 9555
  - » Iridium Extreme.

The modem and the phone handsets provide the same functions (except for Iridium PTT) as the internal Iridium modem, providing phone calling, messaging, and data. These functions are all controlled by the DZMx Plus, so it is not necessary to use the phone keypad.

To configure the DZMx Plus for the connected phone or modem, in DZMx Connect, go to *Settings > Hardware > External > Debug Port Config*, select the modem or cradle version:

- » Iridium 9505A
- » Iridium 9555
- » Iridium Module
- » Iridium Extreme

You will need to check the detailed configuration for each modem and external device in *Settings > Modem*.

### *Iridium Certus modems*

If a satellite data service is required, the Guardian G6 or G6S Iridium Certus midband terminals can be installed and integrated with the DZMx. These terminals provide

- » An IP data connection at 88kbps uplink and downlink
- » A voice service.

### **Configuring the DZMx Plus for other external devices**

Other devices may be connected to the DZMx Plus RS232 serial port. The DZMx Plus needs to be configured to recognise and control the connected device. In DZMx Connect, go to *Settings > Hardware > External > Debug Port Config*,

The following are currently supported:

- » Rhotheta Direction Finder
- » Erickson AWTC
- » ETM Cycle Counter
- » AFDAU (Automated Fire Data Acquisition Unit).

### **SIM Cards**

SIM cards may be required for operation of the DZMx Plus modems

- » A SIM card is required for a DZMx Plus cellular modem
- » A SIM card is required for an internal Iridium 9523 if it is to be used for phone calling and SMS messaging
- » A SIM card is not required for the Iridium 9523 modem if it is to be used only for Iridium PTT or for Iridium SBD
- » A SIM card is not required for an Iridium 9603 (SBD only) modem.

The DZMx Plus uses standard SIM cards, rather than the micro and nano versions.

### *SIM Slot Designation*

SIM card slots are allocated as follows:

- » SIM 1 is allocated to the modem (Iridium or cell) in internal slot 4.
- » SIM 2 is allocated to the modem (Iridium or cell) in internal slot 5.

**Note:** Iridium and cellular SIM cards can be used in both slots depending on the unit configuration purchased.

### *Installing SIM cards*

SIM cards are installed in the SIM card tray inserted in the back of the DZMx Plus. To install SIM cards:

- » Undo the screws securing the SIM card tray and remove the tray.
- » Preferably place the tray on the edge of a hard surface such as a table or book.
- » Position the SIM card with the bevelled corner (circled in drawing) forward and contacts downward, then slide the front edge into the recess in the front of the tray.
- » Tilt the card downward until it clicks into the groove in the tray.
- » Insert the tray into the slot on the back of the DZMx Plus and secure in place with the two cap screws.

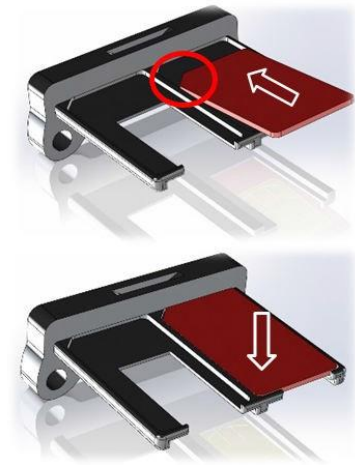

**Note:** Ensure that the SIM cards are in the correct slots, as they may be permanently damaged if incorrectly installed.

### *Iridium SIM cards supplied with your DZMx Plus*

DZMx Plus with Iridium modems are shipped with an unregistered Iridium SIM installed, unless otherwise requested. This can be registered to your Iridium Service Provider's account when you are ready to activate your Iridium service.

To transfer the SIM card to your ISP, please contact Flightcell International at [tech@flightcell.com](mailto:tech@flightcell.com) advising the serial number of your DZMx Plus and the name of your ISP.

## **Configuring Modems**

The DZMx Plus is configured prior to shipment with default settings for the installed modems. However, you may need to check and modify these settings. This is done in DZMx Connect. Go to *Settings > Modems*.

### *Configure which modems are used to transmit tracking data*

By default, tracking messages are enabled for all modems. If more than one Iridium device or more than one cell modem is installed, only one of each should be activated for tracking.

If the internal Iridium 9523 modem is used for Iridium PTT, then the other Iridium modem (9523 or 9603) or external Iridium device should be configured for tracking.

### *Configure Iridium or cellular voice calling capability*

By default, voice calling is enabled for all modems, except for the Iridium 9603 modem, which is used for SBD messaging only, and the 450 MHz cellular modem, which is for data only.

### *Configure Iridium SBD Transmission*

If your Iridium modem has been provisioned to send SBD messages to your chosen tracking provider, then ensure SBD transmission is enabled for your Iridium device. If you do not wish your device to send SBD messages, then disable SBD transmission.

### *Configure the Iridium Service Centre*

Most Iridium accounts use the standard Iridium Service Centre for handling SMS messages. However, some Iridium Service Providers use different SSNs (e.g. Telstra and Pivotal in Australian; DISA for US military).

If **(No SMS)** is displayed next to the Iridium modem's status message on the DZMx Plus display, the service centre number is incorrectly set. The service centre number can be selected:

- » Use DZMx Connect. Go to *Settings > Modem > Modem 1 > Service Centre Number* and select the correct option .
- » Use the DZMx Plus control head. Go to MENU > Hardware Config > Modem Config > Iridium Modem 1 > Service Centre Number and select the correct option.

### *Configure the cellular APN*

It is necessary to set the APN (Access Point Name) for the cellular modems to allow the modem to use cellular data services. You will need to determine the APN for your cellular provider; this can normally be obtained from their website. This is often (but not always) **Internet**.

### *Enable or disable data*

Use this setting to enable or disable data services for the selected modem.

### *Data Roaming*

If a cell modem is operated outside its home country, it is usually necessary to activate data roaming to allow use of local cellular services.

### *Disabling Cell Modems*

In some cases, it may be a requirement to disable cell modems in flight for operational or regulatory reasons.

The DZMx Plus may be configured so that:

- » Cell modems are always enabled.
- » Cell modems can be disabled via softkey - the modem can be disabled manually on the DZMx Plus, using a long press on the A or B softkey allocated to that modem.
- » Cell modems are automatically disabled when the aircraft is in flight.

When a cell modem is disabled, all transmit and receive functions are completely disabled.

These settings can be changed using DZMx Connect. Go to *Settings > Modem > Cell modems*.

**Note:** When set to automatically disable in flight, the manual disable/enable key can override the automatic option until the next take-off or landing.

## Configuring the cellular bands used by the DZMx Plus cellular modem

The cellular modems installed in the DZMx Plus can access 4G (LTE) and if available, 3G and 2G (GSM) services on the cell networks. For each of these services, there will usually be several cellular frequency bands.

3G and 2G services are being retired on cell networks around the world, but the timing of this varies by country and network.

The cell modem will switch automatically between services and bands, under the control of the network. This may result in the modem operating on a service and band which does not provide the best available performance, e.g. the modem may be operating on 3G even though a faster service is available on 4G.

The cellular bands used by the DZMx Plus can be configured to improve its performance. On DZMx Plus, the cell modems can be locked into 4G using the DZMx Plus Advanced Band Select settings.

To lock to specific services and bands,

- » Go to *Settings > Preferences > Regional > Cell Modem Region* and select *Advanced Band Select*
- » Go to *Settings > Preferences > Advanced Band Select* and select the preferred band(s).
- » The following table shows the cellular bands and frequencies for the different regional variants in the DZMx Plus.

Region	LTE (4G)	UMTS (3G)	GSM (2G)
Asia Pacific / South America	B1 (2100)	B1 (2100)	
	B3 (1800)	B5 (850)	900
	B5 (850)	B8 (900)	1800
	B7 (2600)		
	B8 (900)		
	B28 (700)		
Europe	B1 (2100)	B1 (2100)	
	B3 (1800)	B8 (900)	900
	B7 (2600)		1800
	B8 (900)		
	B20 (800)		
	B28 (700)		
Europe 450MHz	B3 (1800)	B1 (2100)	900
	B7 (2600)	B8 (900)	1800
	B20 (800)		

	B31 (450)		
Americas	B2 (1900)	B2 (1900)	-
	B4 (1700)	B4 (1700)	
	B5 (850)	B5 (850)	
	B12 (700)		
	B13 (700)		
	B14 (700)		
	B17 (700)		
	B66 (1700)		

- » The following guidelines can be considered when using advance band select:
- » Locking into LTE only will generally give better data speeds, but if the LTE coverage in your area is not as extensive as 3G, you may need to select both 3G and 4G bands
- » Lower frequency cellular bands (in the range 700 to 850 MHz) will generally give better service than higher frequency bands.

**Note:** When set to automatically disable in flight, the manual disable/enable key can override the automatic option until the next take-off or landing.

## Backlighting

The DZMx Plus Control Head has a backlit keypad and LCD display.

The display and keypad backlighting can be adjusted independently.

Display and keypad lighting can be controlled:

- » Manually from the DZMx Plus Control Head keypad
- » From the cockpit dimmer control. Where one or more remote heads are installed, the control head and remote head may be controlled independently, or the inputs may be coupled together for control by a single dimmer control.

### NVIS Backlighting Options

The DZMx Plus Control Head is available in either NVIS-B compatible or NVIS-A versions. Most DZMx Plus installations will be NVIS-B; the NVIS-A versions are only required by some military organisations (mainly in the USA).

The NVIS-A versions use NVIS-A LEDs in the display for night operation only, using NVIS-B LEDs during day operation, and use NVIS-A LEDs in the keypad.



## Manual Backlight Control from the DZMx Plus Control Head keypad

- » The operator can access the lighting settings from the '*Head Menu*' by pressing the \* key for 2 seconds then releasing.
- » Select the backlight mode (*Day* or *Night*) by highlighting *Backlight Mode* and using the *LEFT* ◀ or *RIGHT* ▶ keys
- » Scroll down to *Display Brightness* and use the *LEFT* ◀ or *RIGHT* ▶ keys to change the brightness level
- » Scroll to *Keypad Brightness* and use the *LEFT* ◀ or *RIGHT* ▶ keys to change the brightness level
- » Changes are stored and take effect immediately.
- » To exit the Head Menu press the *BACK* or the *END* keys.

## External Backlight Control from a Dimmer

### *Wiring the external dimmer control*

An external dimmer control is connected

- » On the DZMx Plus: To General Purpose Input 5 (pin 58 on the main connector).
- » On the Control Head: Direct to the dimmer control input (pin 10).

### *To Test External Lighting Input*

First, ensure the dimmer lighting control input is working correctly as follows:

- » On the DZMx Plus Control Head, enter the '*Head Menu*' by pressing the \* key for 2 seconds.
- » Select *Advanced > Head Diagnostics*
- » Adjust the dimmer control through its full range and observe the '*Input:*' value changing, it should swing between approximately 0 and 3200 for a nominal input range of 0 to 28 volts, however a smaller range may be used

### *External Lighting Control Modes*

There are a range of ways an external dimmer control can operate. The DZMx Plus Control Head has several modes designed to provide for the different options.

- » External lighting mode *Day-Night*
  - » *Variable Night* - backlighting is calibrated for night only
  - » *Variable Night/Fixed Day* - backlighting varies during night but switches to fixed level during the day, when the dimmer control is rotated below a detent.
- » External lighting mode *Night-Day - Variable Night and Variable Day*, transitioning at a designated input threshold.

## Configuring External Lighting modes

### Configure 'Variable Night' Settings

- » Enter the 'Head Menu' by pressing the \* key for 2 seconds.
  - » Set Backlight Mode to <Ext >
  - » Set Ext B'light Mode to <Day-Night > using the LEFT ◀ or RIGHT ▶ arrow keys.
  - » Select External Lighting Config press ENTER.
  - » Select Ext Lighting Night Low press ENTER.
  - » Set the dimmer control to its minimum.
  - » Adjust the following settings:
    - » Set *Display brightness lo* to desired brightness.
    - » Set *Keypad brightness lo* to desired brightness.
    - » Select the *Input calib. (hit Enter) <value >* row and press the ENTER key to sample the input. Note, this value may be overridden by using the LEFT ◀ and RIGHT ▶ keys to adjust.
1. Exit the menu one level by pressing the BACK key.
- » Repeat steps 5 to 7 above for *Ext Lighting Night High*, setting the dimmer control to its maximum.

### External lighting mode Variable Night

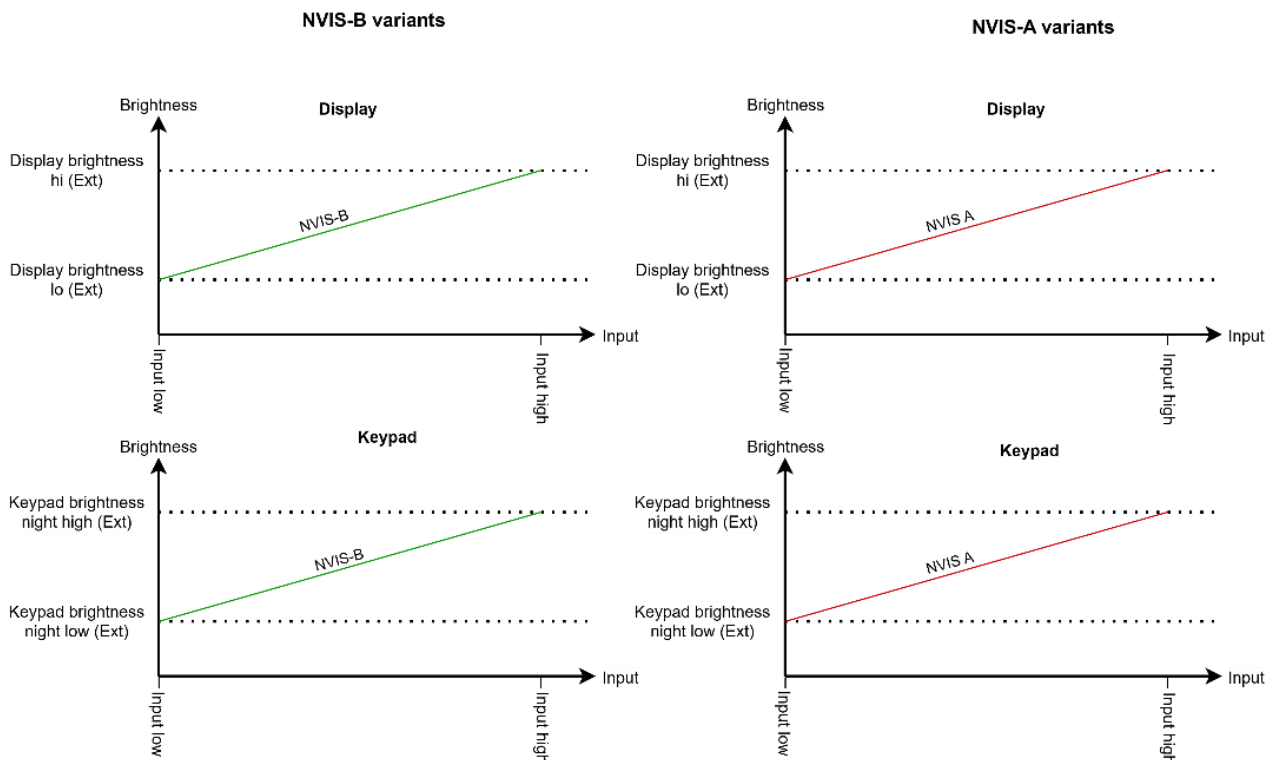

### Configure 'Variable Night / Fixed Day' Settings

Follow the steps as per *Variable Night* mode, but in step 6 above set the dimmer control to the detent position.

In this configuration the backlighting will now switch to the 'Day' brightness settings once the input is below the detent.

**Note:** A hysteresis band is used to prevent the accidental switching into day mode, the size of which can be adjusted using the **Ext Lighting Hysteresis** setting, see **Input Filtering** section below.

### External lighting mode Variable Night - Fixed Day

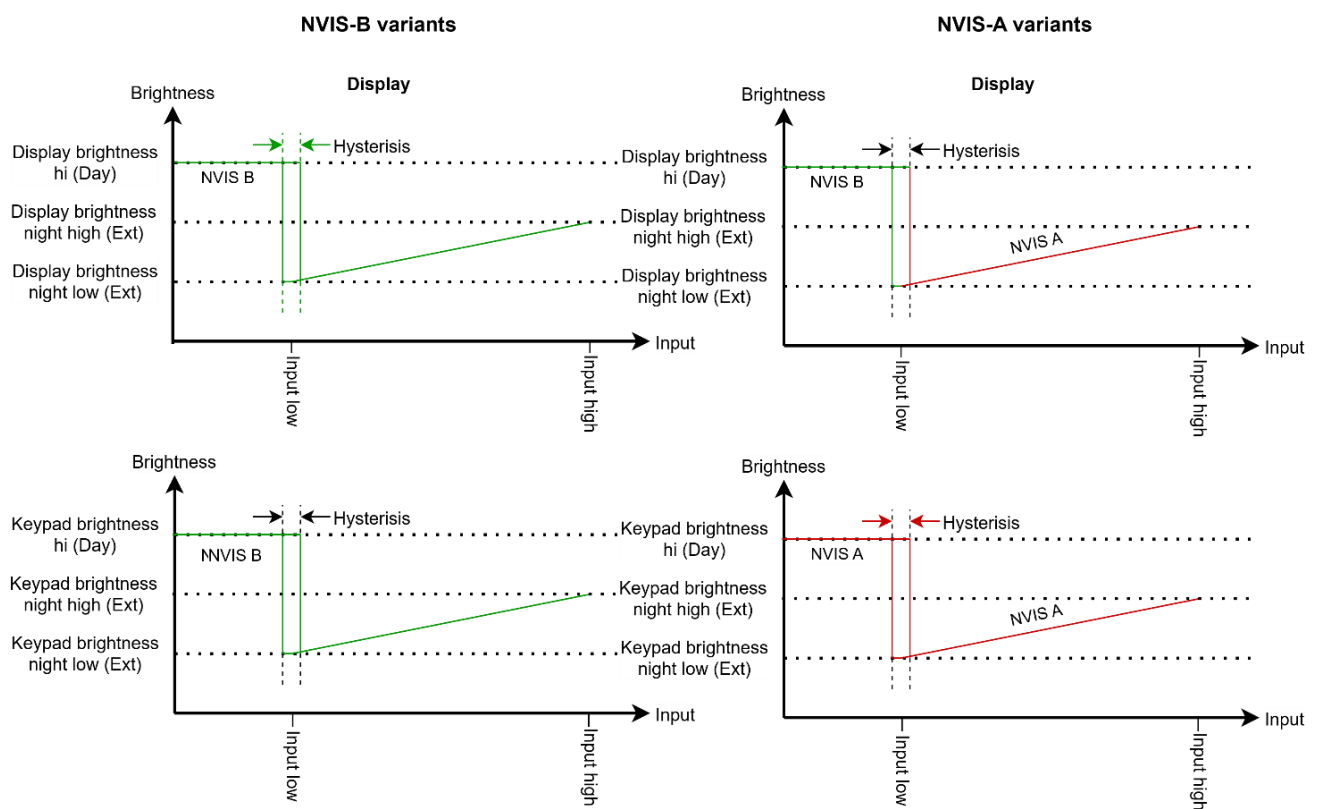

## Configure 'Variable Night and Variable Day' Settings

- » Enter the *Head Menu* by pressing the \* key for 2 seconds.
- » Set *Backlight* mode to <Ext> .
- » Set *Ext B'light Mode* to <Night-Day> using the *LEFT* ◀ or *RIGHT* ▶ arrow keys.
- » Follow steps 5 to 7 as per *Configure variable night mode* above, setting the dimmer control and night brightness as desired for the 'night' range.
- » Repeat the steps 5 to 7 above for configuring *Ext Lighting Day Low/High*' settings as desired for the 'day' range.

**Note:** The voltage values in the diagram below are examples only. The actual values when the head backlighting is calibrated may differ.

### External lighting Variable Night and Variable Day

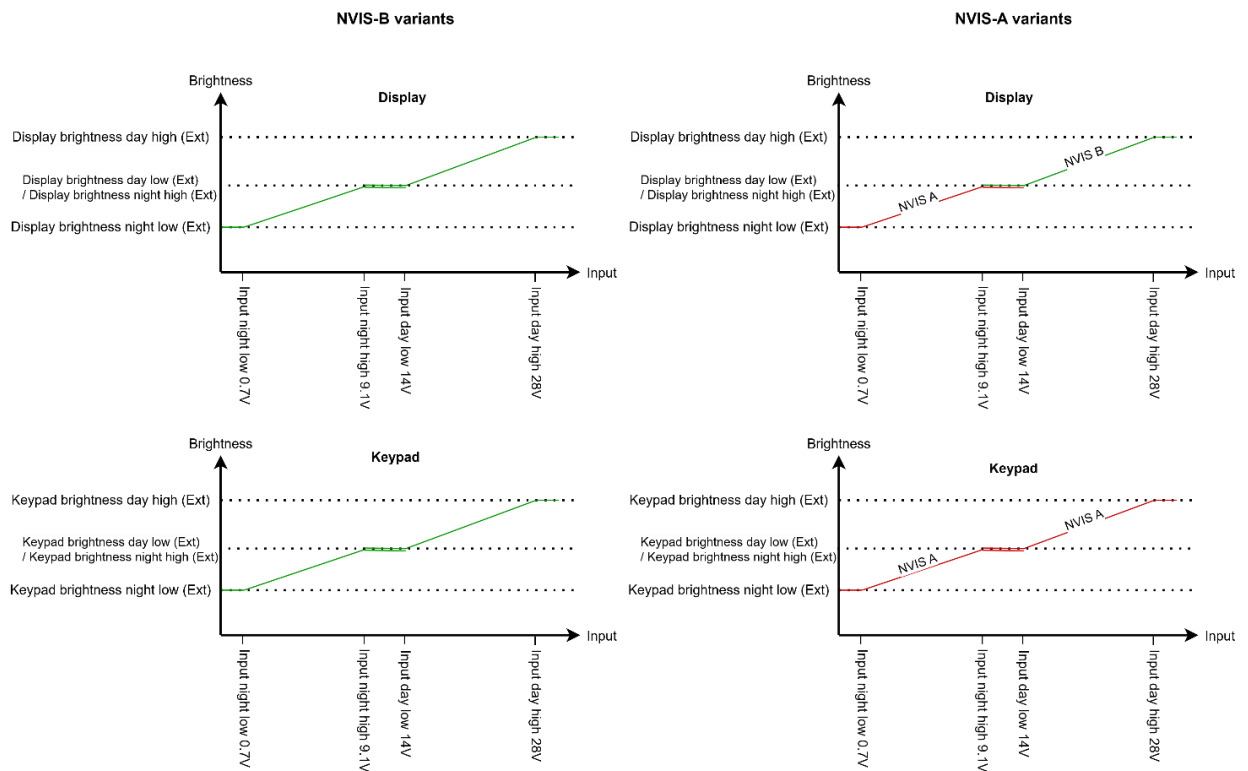

### *External Brightness Control Settings Rules*

The external dimmer control can only drive with a 'positive slope' i.e. the 'high' values must be greater than the 'low' values, as follows:

- » Display/Keypad Brightness High values must be greater than Display/Keypad Brightness low values respectively.
- » *Input calib* value for *Night High* must be greater than *Night Low*.
- » If Ext B'light Mode is set to Night-Day then:
  - *Input calib* value for *Day High* must be greater than *Day Low*
  - *Input calib* value for *Day Low* must be greater than *Night High*

However, when in *Variable night* and *Variable day* mode the day brightness levels may be set to the same or lower than the night values if desired.

### *Input Filtering*

The *Ext Lighting Hysteresis* setting is in units of ADC counts as per the input value, and it is used to filter out small changes on the input to avoiding 'flickering'.

It is also used in the *Ext B'light Mode = Day-Night* mode to help prevent accidental switching into **Day** mode, as illustrated in the diagram.

**Note:** Making the hysteresis value too large will cause a 'dead spot' in the control, which will be particularly noticeable in a configuration with a small input swing.

### *Night / Day Switching Margins*

To avoid potentially hazardous mode switching e.g. from night today due to drift on the input, a switching margin/offset may be added during configuration by overriding the dimmer *Input calib* values by using the *LEFT* ◀ and *RIGHT* ▶ keys.

Tuning these values should be done in association with the **Ext Lighting Hysteresis** value.

## DZMx Plus Data

The DZMx can provide a connection to the internet over a cellular data connection or over a connected Certus modem (such as the Guardian G6 or G6S). Connected devices such as a mission computer, laptop, phone or tablet, or medical device can connect to the DZMx via its Ethernet port or Wi-Fi connection.

The DZMx data connections and services are configured in DZMx Connect in *Settings > Network*. Alternatively they can be configured on the DZMx control head in *MENU > Hardware Config > Wireless and Networks*.

**Note:** Menus for DZMx data settings have been changed in DZMx firmware 3.8.1/4.8.1. Network settings have been brought together in *Settings > Network*.

### Advanced data routing functions

Advanced routing capabilities have been introduced on the DZMx from firmware 4.11 to provide improved data services where the DZMx has more than one data-capable modem installed, for example if the DZMx has more than one cell modem installed, and/or an Iridium Certus modem.

Configuration of advanced routing functions is described *Appendix 2. Advanced routing functions*, on Page 82.

### Ethernet Configuration

The DZMx Plus has one standard Ethernet port. A second Ethernet port is available as an option. DZMx Plus Ethernet can be configured to suit the network configuration on the aircraft.

**Note:** It is recommended to configure Ethernet settings on the DZMx Plus Control Head if the DZMx does not have Wi-Fi.

The DZMx Plus can be set as a DHCP server, a DHCP client, or allocated a fixed IP address.

- » DHCP server is the default mode. This is used where another device connects over Ethernet direct to the DZMx Plus.
- » DHCP client mode may be used where the DZMx Plus is connected to a switch or router which operates as the DHCP server. The DZMx Plus will be allocated an IP address by the connected switch or router.
- » A static IP address may be required in some network configurations.

These options can be selected using DZMx Connect or on the DZMx Plus Control Head.

To determine the IP address the DZMx Plus is using, go to *MENU > Diagnostics Menu > About DZMx Plus*.

**Note:** The DZMx Plus IP address will only be shown in the diagnostics page if the DZMx Plus is connected to an Ethernet connection.

### *DHCP Server Mode Configuration*

The DZMx Plus operates as an internet router while in DHCP Server mode. The default IP address for the DZMx Plus is 192.168.4.1.

When a device is connected to the DZMx Plus Ethernet connection, the DZMx Plus DHCP server will allocate the connected device an IP address in the range 192.168.4.xxx.

**Note:** When using this mode, ensure that there are no other devices on the network configured as a DHCP server.

### *DHCP Client IP Mode*

In this mode, NAT interface can be activated if required.

### *Static IP Address Configuration*

The DZMx Plus is able to configure its Ethernet connections with a host IP address, gateway IP address, and DNS server.

#### **Host IP address**

The host IP address is the IP address of the DZMx Plus.

#### **Default Gateway Configuration**

The default gateway is the IP address of the network node that serves as an access point to the rest of the network. Leave blank if the DZMx Plus is providing the data connection to external devices on the network.

#### **DNS Configuration**

Optionally, the DNS server settings can be configured to set up to two separate DNS servers (primary and secondary).

### *Summary of DZMx Plus Ethernet configuration options*

DHCP Server	DHCP Client	Static IP Address
	NAT Interface Mode	Host IP Address
		Host Subnet Mask
		Gateway IP Address
		DNS Primary Server
		DNS Secondary Server
		NAT Interface Mode

### *Configuring the Secondary Ethernet Connection*

The secondary Ethernet can be configured in the same way as the primary Ethernet.

**Note:** Configuration options for the secondary ethernet connection will only be available if the second ethernet circuit card is installed in the DZMx Plus.

## Controlling IP packet forwarding

The DZMx Plus provides a mechanism to enable/disable IP forwarding between Wi-Fi and Ethernet, to allow wired networks to be isolated from the wireless network.

This is configured by going to *Settings > Network > Firewall*.

When enabled, data can be forwarded between the DZMx Plus Ethernet and Wi-Fi networks. When disabled, wired and Wi-Fi networks connected over the DZMx Plus cellular data connection are separated.

## Configuring Cellular Data

Cellular data can be enabled or disabled in DZMx Connect by going to *Settings > Modems*.

If the DZMx Plus has one cell modem, this will be designated Modem 2. If dual cell modems are installed, these will be Modem 1 and Modem 2.

Data roaming can be enabled

- » Toggle “*Enable Data*” to on to allow cellular data to be used.
- » Set *Data Roaming* if you need to allow cellular data to be used outside the area coverage of your cellular account.

## Set the Access Point Name (APN).

The APN setting must be configured to establish a data connection. The Access Point Name (APN) is the name your cellular modem uses to set up a connection to the gateway between your carrier's cellular network and the public Internet. The APN you need to specify will depend on the cellular network service provider. The APN is often published on the service provider's web site.

This setting is easier to enter via DZMx Connect, where you can type or paste in the APN. It can also be entered using the DZMx Plus Control Head.

## DZMx Plus Wi-Fi

The DZMx Plus is supplied with integrated Wi-Fi components.

DZMx Plus Wi-Fi is a licensed application; purchase of a Wi-Fi licence is required to activate the Wi-Fi service on the DZMx Plus.

DZMx Plus Wi-Fi allows the DZMx Plus to act as an access point to connected devices, enabling the DZMx Plus to be used to route DZMx Plus data connections to connected devices, including:

- » PCs.
- » Tablets.
- » Smartphones.
- » Medical devices.
- » Other specialised devices.
- » Provide WPA2 encryption security to wireless devices.

## Starting Wi-Fi

If the DZMx Plus is Wi-Fi capable and the Wi-Fi licence has been activated, the Wi-Fi service is active by default.



When Wi-Fi is enabled, a wireless icon  will appear at the top right of the screen on the front panel.

It is possible to toggle Wi-Fi on and off from the front panel using a long press on the *MODE* key.

## Disabling Wi-Fi

Wi-Fi can be disabled on the DZMx if it is not required. Go to *MENU > Hardware Config > Wireless and Networks > Wireless Enable*, or in DZMx Connect *Connectivity > Wi-Fi*.

If it is necessary to disable Wi-Fi so it cannot be overridden by the flight crew, the **MODE** key function can be disabled using DZMx Connect.

- » Go to *Settings > Preferences > Main Screen Options > Mode Button Function*.
- » Select required option (*Disabled, Toggle Wi-Fi, Toggle Bluetooth, Toggle BT and Wi-Fi*).

If it is necessary to disable Wi-Fi so it cannot be overridden by the flight crew, the *MODE* key function can be disabled using DZMx Connect.

- » Go to *Settings > Preferences > Main Screen Options > Mode Button Function*.
- » Select required option (*Disabled, Toggle Wi-Fi, Toggle Bluetooth, Toggle BT and Wi-Fi*).

## Wi-Fi Settings

The default Wi-Fi settings are:

- » SSID *DZMx Wi-Fi*
- » Passcode *flightcell*

**Note:** It is strongly recommended the SSID and Passkey be changed to unique values for each DZMx installation (aircraft).

Wi-Fi settings can be configured using DZMx Connect. Go to *Connectivity > Wi-Fi*.

**Note:** The Wi-Fi security settings in the DZMx have been upgraded from firmware 4.11.0, see next page.

The wireless security settings can be modified in DZMx Connect on the *Connectivity* page. :

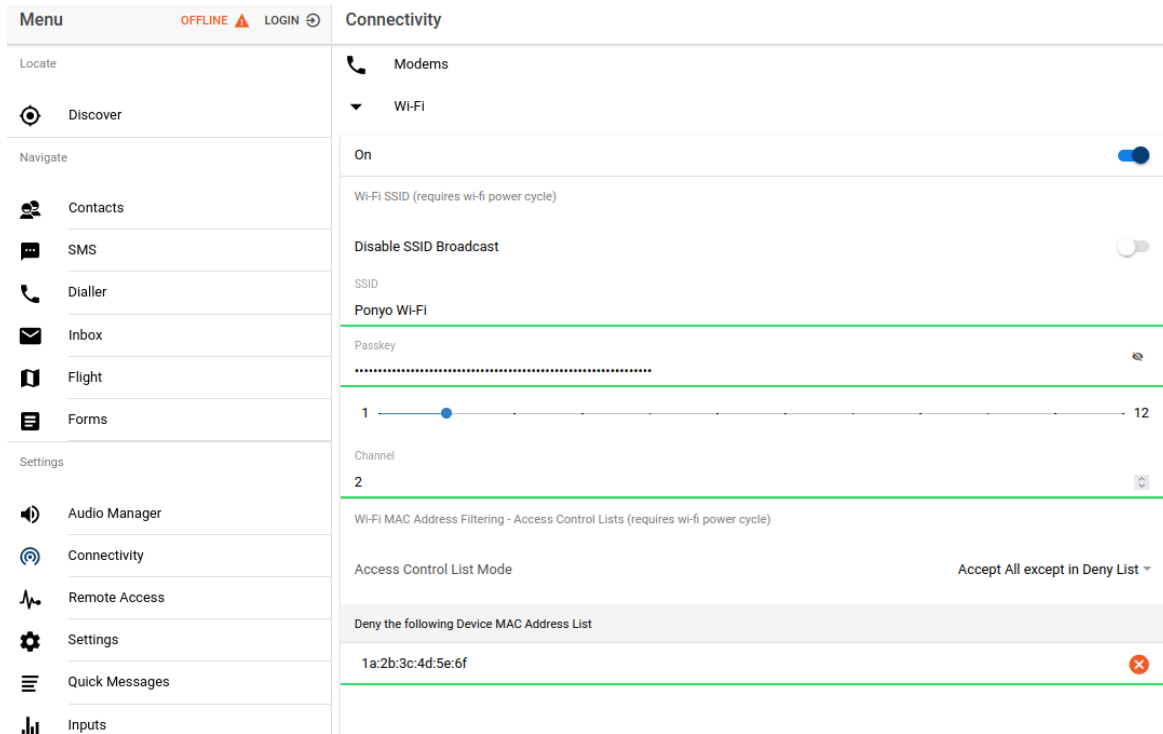

## SSID

The DZMx will normally broadcast the SSID to facilitate connection to the DZMx Wi-Fi.

If required, SSID Broadcast can be disabled to prevent unauthorised persons seeing the DZMx Wi-Fi. Only devices that have previously logged into the DZMx Wi-Fi and have the current SSID and passkey will connect automatically.

## Passkey

When the passkey is changed, the DZMx will require the new passkey include one or more of each of the following: Upper case letter; lower case letter; number; special character.

Once the passkey has been changed and Wi-Fi settings updated, the passkey is no longer human-readable and will be represented by a string of characters, in order to prevent copying of the passkey.

## Advanced security via access control

The DZMx can implement enhanced security by limiting the specific devices which can access its Wi-Fi.

A MAC address is a unique identifier for an electronic device such as a smartphone, tablet or PC.

MAC address filtering is available to allow only specified MAC addresses into the Wi-Fi network or deny specific MAC addresses from connecting to the Wi-Fi network. This is handled by the Access Control List.

To allow only specific devices to connect to DZMx Wi-Fi:

- » In *Access Control List Mode*, select *Deny All Except in Accept List*
- » If a connected device is shown in *Currently Connected to Wi-Fi Device MAC Address*, click on + to add to the Accepted list

- » Otherwise, the MAC address for the device can be entered manually.

Once any devices are added to this list, only those devices will be able to connect to the DZMx Wi-Fi.

To remove devices from the list, click on the X next to the MAC address.

To deny specific devices access to DZMx Wi-Fi,

- » In Access Control List Mode, select *Accept All Except in Deny List*
- » If a connected device is shown in *Currently Connected to Wi-Fi Device MAC Address*, click on + to add to the Denied list
- » Otherwise, the MAC address for the device can be entered manually.

Once any devices are added to this list, those specific devices will not be able to connect to the DZMx Wi-Fi.

To remove devices from the list, click on the X next to the MAC address.

## DZMx Plus Bluetooth™

DZMx Plus Bluetooth is a built-in option that works with any DZMx Plus.

DZMx Plus Bluetooth is a licensed application; purchase of a Wi-Fi or Bluetooth licence is required to activate Bluetooth on the DZMx Plus.

DZMx Plus Bluetooth provides the ability to pair a mobile device, such as mobile phone or tablet, to the aircraft ICS/headset. This is like the hands-free operation in a motor vehicle.

Functionality includes:

- » Making and receiving calls on a mobile device and talk via the ICS and headset.
- » Listening to streaming media on a headset from a mobile device.

If Bluetooth menu options are not available, this functionality will need to be purchased and then activated with a software key supplied by Flightcell International Ltd.

**Note:** Cellphone and Bluetooth technologies are regularly changing. Autoconnection and maintenance of a reliable connection between cellphones and the DZMx Plus via Bluetooth cannot be guaranteed.

A cellphone connected via Bluetooth to the DZMx Plus should not be used for mission critical communication. Call forwarding to the DZMx cellular number is advised.

## Enabling Bluetooth

Once Bluetooth is enabled, it is possible to toggle it on and off from the front panel using a long press on the *MODE* key.

When Bluetooth is enabled, the Bluetooth  icon will appear at the top right of the screen on the front panel.

Bluetooth can be disabled in the DZMx Plus Control Head menu: Go to *MENU > Hardware Config > Wireless and Networks > Bluetooth Enable*.

## Pairing

- » Check that the Bluetooth icon is showing on the DZMx Plus Control Head display.
- » Make the DZMx Plus Bluetooth discoverable using the:

- » DZMx Connect. Go to *Connectivity > Bluetooth*. Ensure Bluetooth is toggled **On**.
- » DZMx Plus Control Head. Go to MENU. > Hardware Config > Wireless and Networks > Bluetooth Discoverable.
- » Enable Bluetooth on the mobile device settings and select the 'DZMx Plus Bluetooth' device.
- » A pairing notification message with a confirmation code will appear on the DZMx Plus Control Head and the mobile device. Ensure they are the same number.
- » Press the **ENTER** key on the DZMx Plus Control Head, then select **Pair** on the mobile device.

### *Connecting paired Bluetooth devices*

The DZMx Plus may be configured to require devices to be connected manually each time, or to automatically connect the last connected device.

- » Use DZMx Connect. Go to *Connectivity > Bluetooth*. Toggle Discoverable ON and Auto connect ON.
- » Use the DZMx Plus Control Head keypad. Go to *MENU > Hardware Config > Wireless and Networks > Bluetooth Autoconnect*.

**Note:** The auto-connect functionality may vary depending on the mobile device and the level of support provided by the operating systems.

A high degree of variability is present across all Android devices. They may need to be connected manually

## **Hands Free Calling**

The DZMx Plus supports a Bluetooth audio hands free profile called HFP. If a Bluetooth device is connected in this mode and pairing has been successful, the DZMx Plus Control Head will display a mobile phone icon in the top left corner of its display (see 'Pairing' above). If a user receives or initiates a call on the paired mobile device, the audio will be routed to/from the ICS/Headset.

## **Media Streaming**

The DZMx Plus supports a Bluetooth Audio Streaming Protocol (A2DP). If a Bluetooth device is connected and pairing has been successful, the DZMx Plus will display a musical icon in the top left corner of its display (see 'Pairing' above). When the user starts audio playing on the connected mobile device it will be audible through the ICS/Headset.

**IMPORTANT NOTE RELATING TO DZMx Plus BLUETOOTH MODEM:** To comply with FCC requirements, the BT800 must not be co-located or operating in conjunction with any other antenna or transmitter.

### **Federal Communication Commission Interference Statement**

This equipment has been tested and found to comply with the limits for a Class B digital device, pursuant to Part 15 of the FCC Rules. These limits are designed to provide reasonable

protection against harmful interference in a residential installation. This equipment generates, uses, and can radiate radio frequency energy and, if not installed and used in accordance with the instructions, may cause harmful interference to radio communications. However, there is no guarantee that interference will not occur in a particular installation. If this equipment does cause harmful interference to radio or television reception, which can be determined by turning the equipment off and on, the user is encouraged to try to correct the interference by one of the following measures:

1. Reorient or relocate the receiving antenna.
2. Increase the separation between the equipment and receiver.
3. Connect the equipment into an outlet on a circuit different from that to which the receiver is connected.
4. Consult the dealer or an experienced radio/TV technician for help.

**FCC Caution:** Any changes or modifications not expressly approved by the party responsible for compliance could void the user's authority to operate this equipment.

This device complies with Part 15 of the FCC Rules. Operation is subject to the following two conditions: (1) This device may not cause harmful interference, and (2) this device must accept any interference received, including interference that may cause undesired operation.

## DZMx Plus Messaging

The DZMx can send and receive text messages (SMS) over its satellite and cellular connections.

Messages can be composed and sent from DZMx Connect.

The DZMx Plus also has a Quick Message Library containing up to 50 pre-defined messages. These can also be sent to a cellphone or satellite phone or attached to a position report (see Manual Reports on page 48).

### Editing the Quick Message library

Quick Messages can be added, deleted or edited in DZMx Connect in *Quick Messages*.

### Adding a position to Quick Messages

The DZMx Plus can be configured to include the aircraft position when a quick message is sent. The received message will show the position and a small preview, and the position can be opened on Google Maps.

To provide for attachment of a position, go to *Settings > Tracking > General* and turn on *Include Position in Quick Msg*.

## DZMx Plus Tracking

The DZMx Plus has an embedded GPS, which provides precise information on the current state of the aircraft.

This information can be sent to a tracking provider to enable the aircraft to be monitored and its movements tracked.

The DZMx Plus tracking system provides information on:

- » Position, altitude, heading and speed

- » Flight state - on ground, hovering, flying, unknown

To use the DZMx Plus tracking capability, it is necessary to enter a contract with a tracking service to receive, process and display tracking information. The DZMx Plus must then be configured to work with that tracking service.

Position reports are sent at intervals. The DZMx Plus cannot provide continuous tracking due to the constraints of the networks used but can transmit position reports with an event code attached at regular pre-programmed intervals.

As well as periodic position reports, the DZMx Plus can be configured to automatically send event reports - these are position reports with an event code attached.

**Note:** Most of the menu settings will not be visible unless the user has unlocked the Installer Menu

## Changing Tracking Modes

Tracking settings can be configured using either the DZMx Plus tracking menu or by using DZMx Connect.

Tracking can be disabled (until re-enabled) or suspended (for the current flight only).

To suspend or disable tracking, using the DZMx Plus Control Head go to *MENU > Tracking > Tracking Mode* or on DZMx Connect go to *Settings > Tracking > General > Tracking mode* and select one of the following options:

- » *On*: Turns tracking on until it is disabled or suspended.
- » *Suspend*: Suspends tracking until the DZMx Plus is next powered on
- » *Off*: Turns tracking off until it is manually enabled

## Locking the Tracking Menu

By default, some tracking settings are unlocked and can be altered by the crew to change the main tracking timers.

- » To lock the tracking menu so the crew cannot change these settings:
- » On the DZMx Plus Control head go to *MENU > Tracking Lock > Tracking Menu*
- » On DZMx Connect, go to *Settings > Tracking > General*.

The Tracking Menu will be hidden from view when the DZMx Plus is next restarted.

## Configuring DZMx Plus GPS

The default setting for the GPS receiver in the DZMx Plus provides for a maximum operating altitude of 12,000 meters and a maximum ground speed of 310m/s (603 knots, or 1116 km/hr).

If the aircraft operates at high speed or high-altitude you can change the GPS settings using DZMx Connect. Go to *Settings > Preferences > GPS* and select *General Purpose, High Altitude* or *High Speed* from the dropdown box. Select *OK* followed by *DONE*.

Setting	Max Altitude (m)	Max Horizontal Speed (m/s; knots; km/hr)	Max Vertical Speed (m/s; knots; km/hr)
General Purpose	12,000	310; 603; 1116	50; 97; 180
High Altitude	50,000	250; 486; 900	100; 184; 360
High Speed	50,000	500; 972; 1800	100; 184; 360

## Top Line Display Options

Operating and trip information is displayed on the top line of the DZMx Plus Control Head screen and can be varied to meet your needs. The current available options for the display line are:

- » **Off:** no information shown
- » **Speed and Heading:** the aircraft's speed and heading are shown in knots and degrees relative to true north (rather than magnetic north)
- » **Clock:** the current time and date is shown in UTC (not local) time
- » **TTAF:** Total Time Airframe
- » **DFT:** Daily Flight Time
- » **Trip:** Current trip time.

To set the top line display using the:

- » DZMx Plus Control Head keypad. *Go to MENU > Display Setup Menu > Top Line Options* or
- » DZMx Connect. *Go to Settings > Preferences > Top Line Options.*

## Tracking Providers

Flightcell does not provide a tracking service but works with tracking service providers who support DZMx Plus data. Contact Flightcell for information on available tracking service providers or refer to the list of providers on the Flightcell website (<http://www.flightcell.com/tracking/tracking-providers>).

If you have a preferred tracking provider who is not currently supported by Flightcell, please contact us at [info@flightcell.com](mailto:info@flightcell.com). We are always prepared to support additional providers.

### *Setting up the Tracking Service Provider*

Before your tracking service provider can configure your tracking account, you may need to provide them with the following information:

- » **DZMx Plus Serial Number:** Used to identify your aircraft when data is sent to a tracking provider. You can find your serial number in one of three places:
  - » On the DZMx Plus packaging
  - » On the serial number label on the back plate of the DZMx Plus.
- » By using the DZMx Plus Control Head keypad. *Go to MENU > Diagnostics Menu > About DZMx Plus.* The serial number will be displayed. Press **END** to return to the main screen.

- » **International Mobile Equipment Identity (IMEI):** This is a unique 16-digit number which is located on the backplate label of the DZMx Plus or under the battery of the (optional) Iridium External Device.
- » This can also be found by using the DZMx Plus Control Head keypad. Go to *MENU > Diagnostics Menu > Sat Device Details*. The IMEI number will be displayed.
- » **SIM Card:** The DZMx Plus will usually be delivered with an unlocked, inactivated Iridium SIM Card installed. To activate an account on this SIM card, contact Flightcell and advise the name of your Iridium Service Provider. The contract of this SIM card can then be transferred to your ISP, who will activate an account for this SIM Card.
- » **Iridium Phone Number** if you have an Iridium SIM card installed.
- » **Cellular Phone Number** if you have a cell modem installed.

## Tracking Transmission

The DZMx Connect can send position reports over:

- » The cellular network: Using an IP data connection.
- » The Iridium network: Using the Short Burst Data service (SBD) or SMS.

If you wish to enable a particular modem for tracking, ensure the "**Use for Tracking**" modem setting is enabled and additionally, the "**SBD Enable**" modem setting is enabled for any Iridium modems.

### *Preferred Transmission Mode*

The DZMx Plus can prioritise the available networks used for sending tracking messages. This is particularly useful to allow you to prioritise the cheapest transmission method, enabling least cost tracking while allowing the DZMx Plus to fall back to the alternate network if there is no coverage on the preferred network.

DZMx also allows tracking messages to be sent from modem while the other is in use for calls/data.

To set the preferred transmission mode:

- » Using DZMx Connect. Go to *Settings > Tracking > Transmission > Preferred Device*
- » Using the DZMx Plus Control Head keypad. Go to *MENU > Tracking > Transmission Options > Preferred Device*.
- » Select one from the list below.
  - » **Try Sat First:** If messages cannot be transmitted over the Iridium satellite network the DZMx Plus will send them over the cellular network.
  - » **Try Cell First:** If messages cannot be transmitted over the cellular network (for example if the aircraft is out of cell coverage) the DZMx Plus will send them over the Iridium satellite network.
  - » **Sat Only:** If the Iridium network is the preferred and there is no signal, tracking messages will be queued.



- » **Cell Only:** if the cellular network is preferred and there is no signal, tracking messages will be queued.

**Note:** During a satellite call, SBD will be unavailable. To ensure tracking is not interrupted, the satellite modem will default to Iridium SMS for tracking, until the call has ended.

### *Configuring DZMx Plus Tracking Destinations*

Once the Tracking Service Provider has your account set up, the DZMx Plus can be configured to send tracking messages to your selected providers. The destination gateways for Iridium and cellular networks need to be configured for each tracking service, they will provide you with the destination addresses. The following tracking gateways can be used with the DZMx Plus:

- » **Iridium SBD:** Destination addresses are configured by your tracking service provider on the Iridium service SPNet.
- » **Iridium SMS:** Configure in DZMx Connect. Go to *Settings > Tracking > Transmission* and enter the destination number.
- » **Cellular Tracking over IP:** Enter the IP address and port number in DZMx Connect. Go to *Settings > Tracking > Transmission* and enter the provided details.

**Note:** If a method of transmission is not supported by your tracking provider, leave the destination address for that transmission method blank.

### *Configuring Tracking over IP using Cellular Data*

If supported by your tracking provider, the DZMx Plus can be configured to send tracking messages via the cellular data connection to an IP address when a data connection is available.

- » Configure the following settings in DZMx Connect: Go to *Settings > Modem*.
  - » **Access Point Name (APN)** for your cellular network: this can be obtained from your cellular service provider or from their website. The normal default APN is **Internet**
  - » **Enable Data:** This setting must be set to **On**. There must be a data connection active to send tracking messages to an IP port.
- » Configure in DZMx Connect. Go to *Settings > Tracking > Transmission*.
  - » **IP address:** Your tracking provider will advise you what IP address setting to use. An example is: 123.123.5.6
  - » **IP port:** Your tracking provider will advise you what IP port number to use. An example is: 12021.
  - » **IP Timeout Profile:** There are three possible settings; **Short**, **Medium** (default) and **Long**. The IP timeout configures the delay used to wait on the connection to the IP gateway from the tracking provider when attempting to send the messages. The shorter the delay, the faster the tracking system will fall back onto another network service to send tracking messages if transmission over IP fails. Setting this to Long will make the system more resilient when the connection is poor, and maximise the use of tracking over IP, but messages could take longer to send.

## Configuring Periodic Events

The DZMx Plus can be configured to send position reports at designated intervals, which depend on aircraft activity. The following events or timers can be configured individually:

- » **Periodic Timer:** The time, in minutes, between sending automated position reports while in flight (15 seconds for HD tracking).
- » **On Ground Timer:** The time, in minutes, between sending automated position reports while on the ground (not in flight).
- » **Taxiing Timer:** The time, in minutes, between sending automated position reports while taxiing.
- » **Hover Timer:** The time, in minutes, between sending automated position reports while hovering. Hover events will replace the periodic events when they are due to be sent. Hovering can only be reported for a helicopter which has a collective or weight on wheels switch to detect take-off and landing. The hover timer cannot be enabled if using speed only.
- » **Heading Timer:** The minimum time, in minutes, between position reports when the aircraft is changing heading.

To Change the Interval for the Selected Timer:

Using DZMx Connect. Go to *Settings > Tracking > Periodic*. Select the required periodic timer settings.

Using the DZMx Plus Control Head keypad. Go to *MENU > Tracking > Periodic Events*. Use the **LEFT** ◀ key to reduce the interval and the **RIGHT** ▶ key to increase the interval. The intervals are displayed in minutes. Press the **ENTER** key to save the setting. Press **END** return to the main screen.

**Note:** Any timer can be disabled by setting its interval to zero.

## Enabling HD Tracking

While tracking interval over Iridium is set in minutes, with tracking over cellular IP, the interval can be reduced to 15 seconds (High Definition Tracking).

To enable or disable HD Tracking using DZMx Connect. Go to *Settings > Tracking > General > HD Tracking Mode* and select one of the following options:

- » **On:** Enables HD tracking, thus allowing up to 1 tracking message to be sent every 15 seconds by the DZMx Plus while a data connection is available.
- » **Off:** Turns HD tracking off, reverts to the periodic tracking interval as set-up in "[Periodic Events](#)".
- » **Cell HD:** Turns HD tracking on for cell, sending position reports every 15 seconds. If messages start to queue, due to being in a poor signal area, then the frequency of the tracking messages will drop back to standard periodic intervals. The rate will switch back to using the HD interval setting as soon as the cell modem gets a good signal and cell data becomes available again.

- » **Full HD:** Turns HD tracking on for cell, sending position reports every 15 seconds, and stores positions every 15 seconds on sat, sending them as a group every minute. The DZMx Plus will send messages out via an SBD message at 1-minute intervals to maintain an HD interval track log when cell data is not available. If cell data is disabled, or no cell modem is fitted it is possible to track in Full HD mode continuously using SBD exclusively. Each SBD message will contain up to 3 crumbs as historical reports, as well as the current position. If the HD interval is set to longer than 15 seconds, then the SBD message interval will also change in Full HD mode e.g. to every 2 minutes when the HD interval is set to 30 seconds.

**Note:** The DZMx Plus will not track at the HD rate when on the ground. The DZMx Plus will use the **On Ground** periodic timer setting (which may be disabled by setting to 0).

### *Configuring the Heading Timer*

If the **Heading Timer** is configured, a position report will be sent as soon as a specified change in heading occurs.

To set the heading variation that triggers a heading change report using DZMx Connect. Go to *Settings > Tracking > Periodic Settings > Heading Variation*.

**Note:** The heading timer only specifies a minimum delay between heading events.

## Configuring automated event reports

### *Power Up*

To send a position report when aircraft power is supplied to the DZMx Plus and when the DZMx Plus is powered off, go to *Tracking > Triggered > Power Notification*.

**Note:** It is recommended that the DZMx Plus be connected to the primary power bus on the aircraft so that the power up message is created when the aircraft is first powered on.

### *Take-off and Landing Events*

The DZMx Plus can be configured to send take-off and landing event reports at the start and end of each flight leg. The simplest approach is to use aircraft speed to trigger take-off and landing reports. This is ideal for fixed wing aircraft. However, while this approach can be used for helicopters, it is not ideal as it can result in false take-off and landing reports when hovering.

To configure the DZMx Plus for take-off and landing events using aircraft speed, go to *DZMx Connect > Settings > Triggered* and set a speed just below take-off speed for the aircraft, and a landing speed just below the aircraft's landing speed.

For helicopters, it is recommended that a collective switch or squat switch (also known as a "wheels on ground" or "weight on wheels" switch) be used to activate these reports. See DZMx Plus Inputs on Page 57 for details on wiring and configuring the inputs.

## Hovering

If in HD tracking mode and hover is enabled, and the aircraft is hovering (speed < 15kts), then the HD tracking rate will drop to 30 seconds on cell and will drop back further to use the slower Periodic Timer rate when cell data is not available, messages are queueing, or speed = 0 (and drops out of HD Mode). If the aircraft is hovering, and hover is not enabled, then the tracking rate will drop to using the standard Periodic Timer rate whilst the aircraft speed is 0 but will switch back to HD as soon as the aircraft is moving again.

## Engine Start and Stop Events

The DZMx Plus can be configured to send an event report when the engine starts and stops. Typically, this is triggered by the transmission oil pressure warning light circuit. See DZMx Plus Inputs on Page 57 for details on wiring and configuring the inputs.

## Configuring Manual Position Reports

The **MARK** key on the DZMx Plus Control head keypad can be configured to send a variety of manual reports:

- » Long press of **MARK** key:
  - » **A position report only**, to the tracking service, or
  - » **Position with text message**: When **MARK** is held for 2 seconds, it opens a list of pre-programmed text messages that can be sent with the manual position report.
- » Short press of the **MARK** key:
  - » **A position report only**, to the tracking service, or
  - » **A mission mark** - this prompts the user to press one of the coloured keys on the DZMx Plus keypad, then the mission number; this is sent to the tracking service, or
  - » **Mark and text contacts** - send a position and message (from the DZMx Plus Quick Message Library) to one or more SMS recipients and the tracking service. This prompts the user to select one of the first 10 Quick Messages to send to the tracking service, along with the current position, and to also send a text message to any contacts in the phonebook that have also been subscribed to be notified of that particular message. Each of the first 10 Quick Messages are assigned an index 1-10, in the order as they appear in the Quick Message list page on DZMx Connect or in the *Pick From List* page on the DZMx. When prompted, select the appropriate index of the quick required.
  - » **Text Contact List Only** - a message is sent by SMS to selected contacts; follow the prompt and enter a number corresponding to a specific message in the DZMx Plus Quick Message Library (see below for details of how to configure the message recipients for this option). A position may also be sent with the message if configured in *Settings > Tracking > General Settings*.

These options are configured using DZMx Connect. Go to *Settings > General > Mark Long Button Press/Mark Short Button Press*.

**Note:** These options are not supported by all tracking service providers. Check with your service provider before activating these options.

### *Sending messages to contact groups*

Pre-defined messages can be sent to one or more contacts when *Mark and text contacts* is selected.

Additional information can optionally be included with the message if the following options are configured in *Settings > Tracking > General Settings*:

- » The aircraft registration number is entered; if the registration number is not entered, the DZMx serial number will be used instead
- » The aircraft position will be included if selected.

### *Configuring message recipients*

The recipients for each Quick Message can be designated using DZMx Connect.

- » In DZMx Connect, go to *Contacts*
- » For the selected contact, swipe the arrow to the left and click *Edit*
- » Click *Quick Message Groups*
- » Tick the index numbers of the messages you want to be sent to this contact
- » Repeat for additional contacts.

The screenshot shows a 'Contact Editor' window with the following details:

- Name:** Nelson Base
- Number:** +6421548019
- Email:** Nelsonbase@nelsonaero.com
- Quick Message Groups:** A section with a dropdown arrow and a list of 10 checkboxes. Groups 1, 2, and 3 are checked, while groups 4 through 10 are unchecked.
- Instructions:** A note stating: "Groups correspond to Quick Message numbers i.e. assigning this contact to a Quick Message group will ensure they receive that Quick Message when it is sent using the Mark key."
- Buttons:** 'SUBMIT' and 'CANCEL' buttons at the bottom right.

If both the phone number and email address are filled out for a contact, the message will be sent by both email and SMS. If only the phone number or the email address is filled out, the message will be sent only by SMS or email, respectively.

**Note:** If different messages are to be sent to the same recipient by email and SMS, it is necessary to create duplicate contacts for that recipient.

## Configuring transmission of event reports to selected recipients

The DZMx Plus can send automated event reports to the tracking service.

It can also be configured to send event reports by SMS and/or email to selected recipients.

Additional information can optionally be included with the event report if the following options are configured in *Settings > Tracking > General Settings*:

- » The aircraft registration number is entered; if the registration number is not entered, the DZMx Plus serial number will be used instead
- » The aircraft position will be included if selected
- » Flight timer information will be included in take-off and landing event reports if selected.

**Note:** Event reports can be sent by SMS and/or email even if DZMx Plus tracking is not being used.

### Configuring recipients for event reports

One or more recipients for each event report can be designated using DZMx Connect.

- » In DZMx Connect, go to *Contacts*
- » For the selected contact, swipe the arrow to the left and click *Edit*
- » Click *Event Message Groups*
- » Tick the event reports to be sent to this contact.

Events that can optionally be sent are Power up and power down, engine start/stop, take-off/landing, emergency events and exceedance events.

If both the phone number and email address are filled out for a contact, the event report will be sent by both email and SMS. If only the phone number or the email address is filled out, the event report will be sent only by SMS or email, respectively

The screenshot shows the 'Contact Editor' interface. At the top, the email address 'Nelsonbase@nelsonaero.com' is displayed. Below this, there are two sections: 'Quick Message Groups' and 'Event Message Groups'. Under 'Event Message Groups', several options are listed with checkboxes: 'Power Events' (checked), 'Engine Start/Stop' (checked), 'Takeoff/Landing' (checked), 'Emergency Modes' (unchecked), and 'Exceedance Events' (unchecked). A note at the bottom states: 'Groups correspond to flight events i.e. assigning this contact to a group will'. At the bottom right, there are 'SUBMIT' and 'CANCEL' buttons.

**Note:** If different messages are to be sent to the same contact by email and SMS, it is necessary to create duplicate contacts.

## Managing the DZMx Plus Message Queue

The DZMx Plus sends position reports and other messages to the selected networks as soon as they are created. Occasionally, the DZMx Plus may lose network connection, which will cause messages to be stored in a message queue until a network connection is restored.

- » The behaviour of this queue can be configured using DZMx Connect. Go to *Settings > Tracking > Queue*
- » Queue size can be set up to store up to 20 messages. Queue size can be entered using text or the sliding bar.
- » Using the dropdown menu select the Queue type. Either “**send the newest messages first**” or “**oldest messages first**”.
- » **Restore Unsent Msgs**; unsent messages in the queue are retained in DZMx Plus memory when it is powered down and sent when the DZMx Plus is started up again. This function can be

**Note:** Some tracking providers are unable to cope with tracking messages that are out-of-order, so it may be required to use the **Send Oldest First** setting.

**Note:** Messages older than 24 hours will not be restored.

## Automated Rescue Monitoring

Automated Rescue Monitoring (A.R.M) also known as Automated Flight Following (AFF) is an optional automated flight monitoring system. When A.R.M. is activated, your tracking service monitors position reports from the aircraft and raises an alert when reports are overdue by a specified period, or (optionally) if the aircraft is stationary for a specified period.

Enabling A.R.M. allows for the feature to be activated when the A.R.M. key is pressed. To enable the A.R.M. function using the DZMx Plus Control Head keypad go to *MENU > Tracking > ARM Enable*.

Not all Flightcell tracking providers support A.R.M. Before activating A.R.M., contact your tracking service provider to determine if they support this function.

**Note:** A.R.M. can only be configured with tracking providers who support this application.

## Alert Mode

Alert Mode allows users to send special alert messages in specific circumstances (e.g. Under Fire).

Alert mode setting can only be enabled using DZMx Connect. Go to *Settings > Tracking > Automated Remote Monitoring*. Toggle “*Arm enabled*” off and “*Alert Mode Enabled*” on.

When enabled, Alert mode is activated using a long press on the DZMx Plus Control Head keypad **A.R.M.** key.



**Note:** A.R.M. and Alert mode cannot be enabled at the same time.

## Geofence Suspend Mode

The Geofence Suspend application allows operators to suspend tracking while the aircraft remains within a set geographical radius. This enables position reports to be suppressed while the aircraft is operating in a localised area, e.g. during crop dusting or Airwork operations.

Moving outside the geofence perimeter will cause geofence mode to be cancelled and normal tracking to resume. Whilst within the perimeter, periodic tracking is suspended and depending on how geofence suspend mode is configured, triggered events, such as take-offs and landings, can also be suspended.

### Setting the Geofence Mode

- » Set the Geofence radius using:
  - » DZMx Connect app. Go to *Settings > Tracking > Geofence > Geofence Settings > Geofence Radius*. Enter the Geofence radius then select **Done**.
  - » DZMx Plus Control Head keypad. Go to *MENU > Tracking > Geofence > Geofence Radius*, press *ENTER*. Use the left ◀ key to reduce the Geofence radius and the right ▶ key to increase the Geofence radius. Press *ENTER* to save then press *END* to return to the main screen.
- » Configure the Geofence Mode Using:
  - » DZMx Connect app. Go to *Settings > Tracking > Geofence > Geofence Mode*. Select the Geofence Mode from the list below. When selected, select OK then select DONE.
  - » DZMx Plus Control Head keypad. Press *MENU > Tracking > Geofence > Geofence Mode*. Select the Geofence mode from the list below.
    - **Disabled** to disable the Geofence application. This will remove the geofence function from the **MENU** key.
    - **Without Events** mode to suspend all tracking messages, except emergency, forms, ETM1000 and manual mark messages.
    - **With Events** mode to suspend periodic and course change tracking messages as above, but all triggered events will still be transmitted.
    - **Events on Cell Only** mode to operate as per With Events mode but with the additional cost- saving feature to only send event messages via cell modem.

Triggered event messages will be queued if the cell modem has no signal until the cell modem obtains a connection to the cell network, or the aircraft flies out of the geofence perimeter. Refer to the DZMx Plus Operators Manual for details of how to activate a geofence.

## DZMx Plus Inputs and Outputs

The DZMx Plus has General Purpose Inputs/Outputs (GPIO) which can be configured to trigger alerts or tracking messages during operation, or to signify some event. The DZMx Plus has five inputs and two outputs. Another seven inputs can be installed with the optional Input Expansion Card (IEC).



## DZMx Plus Inputs

The DZMx Plus general purpose inputs (GPIs) can be used to indicate some event or state on the aircraft. A standard DZMx Plus has five inputs, with another seven inputs available on the optional DZMx Plus Input Expansion Card (IEC). An input may be used for a range of functions:

Uses include:

- » Indicating an event, including, but not limited to:
  - » Engine start and engine stop
  - » Take-off and landing
  - » Release of water from a fire-fighting tank
- » Indicating a level, such as the amount of water in a fire fighting tank
- » Triggering an action on the DZMx Plus, for example:
  - » **Vary backlighting** on the DZMx Plus when controlled from a cockpit lighting controller
  - » **PTT button** to start/stop a IrPTT transmission
  - » **Custom button** to cancel DZMx Plus audio alerts
  - » **Custom button** to turn on or off Wi-Fi and Bluetooth

To trigger an event report; connect to a:

- » Collective switch or Weight on Wheels (Weight on Ground) switch to generate take-off tracking messages
- » **Oil pressure switch:** To generate engine start and stop messages.
- » **Cockpit lighting control** to control DZMx Plus brightness externally from the dimmer control (only available on input 5).
  - » **Rotor brake light** to trigger a Rotor Brake On/Off report.
  - » **Winch control** to trigger winch out/in report.
  - » Custom key to trigger a **Mark** report.

To trigger an action; connect to a:

- » PTT button to start/stop a IrPTT transmission.
- » Custom button to turn on or off Wi-Fi and Bluetooth.

Additional applications can be activated on the DZMx Plus which provides a large range of additional functions for the inputs including:

- » Firefighting Application (see details in the DZMx Plus Firefighting Application Manual).

Custom Inputs can be used for custom applications in addition to those provided already provided on the DZMx Plus.

### *Wiring the inputs*

The inputs can tolerate a voltage range of 0-28VDC, with an over/under voltage protection to  $\pm 32$ VDC. The inputs have two states, **Open** (high voltage) or **Closed** (low voltage). Refer to the Flightcell website at [www.flightcell.com/resources](http://www.flightcell.com/resources) for the wiring diagrams.

Two ground return pins are provided for the five primary GPIs (pin 3 and pin 17 of the primary connector); these are internally connected to power ground and aircraft chassis ground, so the aircraft chassis can be used as a ground return for these GPIs if required.

Input 5 can be configured as either a standard input (see "Configuring Inputs" below), or as a cockpit dimmer control for the DZMx Plus Control Head keypad/LCD brightness.

### *Configuring the inputs*

These inputs can be set up on either the DZMx Plus Control Head keypad (at *MENU > Hardware Config > Input Configuration*) or using DZMx Connect (*Settings > Inputs*). In practice, it is easier to set them up using the DZMx Plus control head as the DZMx Plus reports the status of the input in real time.

Inputs 1 to 5 can be used either as two-state or as variable inputs.

Events can only be triggered on inputs 6-12 (on the input expansion card) by pulling them to ground, as they are two-state inputs.

**Note:** If Input 5 is to be used for the cockpit dimmer control, it cannot be used for other functions.

### *To set up the inputs:*

- » Go to *MENU > Hardware Config > Input Configuration*.
  - » Select the function that you want to assign to an input (e.g. Take-off Switch)
  - » Select Input Designation, then select the input which has been wired for that function or select *Not Installed*.
- » Go to *MENU > Hardware Config > Input Configuration*.
  - » Select the function that you want to assign to an input (e.g. **Take-off Switch**)
  - » Select Input Designation, then select the input which has been wired for that function or select *Not Installed*.
  - » If using the DZMx Plus Control Head a pop-up will show the current state the DZMx Plus reads from this input (e.g. *Up/Down, On/Off*).
  - » If the state is wrong (e.g. DZMx Plus reports "*Collective is Up*" when it is down, go to *Input Configuration* and change the selected condition.

**Note:** Some specialised input functions will only appear in the Input Configuration menu if the application (e.g. airline, firefighting or PTT) is enabled.

## **DZMx Plus Outputs**

The DZMx Plus has two outputs, which are switches that can be used to turn an electrical signal on or off. A typical use of an output is to energise a ring alert light on the aircraft panel.

Each output has two terminals, A and B. The output consists of an isolated switch, internal to the DZMx Plus. When the output is active, the switch is closed (terminals A and B are connected). When output is inactive, the switch is open (terminals A and B are disconnected). The outputs can be configured to flash or simply turn on/off.

The events that can be configured to trigger the outputs on the DZMx Plus are:

- » **Off Hook:** Turned on when the operator is dialling, or in a call.
- » **Incoming Call:** Alerts the operator when there is an incoming call.
- » **PTT Transmitting:** A device in the talk group is transmitting.
- » **Received Msg:** Alerts the operator when a text message has been received or a call has been missed.
- » **Power Indicator:** Alerts the operator when the DZMx Plus is powered on.

To select the allocation of the outputs and the blink pattern using the DZMx Plus Control Head, go to *MENU > Hardware Config > Outputs Config* and select the appropriate setting.

- » Off Hook Output > [Disabled | Output 1 | Output 2]
- » Off Hook Mode > [Off | Solid | Blink]
- » Incoming Call Output > [Disabled | Output 1 | Output 2]
- » Incoming Call Mode > [Off | Solid | Blink]
- » PTT Transmitting Output > [Disabled | Output 1 | Output 2]
- » PTT Transmitting Mode > [Off | Solid | Blink]
- » Received Msg Output > [Disabled | Output 1 | Output 2]
- » Received Msg Mode > [Off | Solid | Blink]
- » Power Indicator Output > [Disabled | Output 1 | Output 2]
- » Power Indicator Mode > [Off | Solid | Blink].

## Exporting GPS data

The DZMx can stream NMEA data from its internal GPS system to an external device (such as a Flightcell SmartHUB) as UDP over its data connection.

To activate, in DZMx Connect, go to *Settings > Preferences > GPS* and turn on GPS Agent.

The destination IP address and port can be configured if required.

The default setting is IP address 192.168.4.255, port 3131.

## Configuring DZMx Plus Data

DZMx Plus data can provide access to the internet for a connected PC, laptop, or Windows tablet over a cellular data connection. These devices can connect to the DZMx Plus via its Ethernet port or Wi-Fi connection.

### Ethernet Configuration

It is recommended that the Flightcell USB/Ethernet module is installed to provide the necessary Ethernet connection.

The DZMx Plus can be set as a DHCP server, a DHCP client, or allocated a fixed IP address.

These can be selected using DZMx Connect. Go to *Settings > Preferences > Local Network > Local Network Settings*.

To access the DZMx Plus data connection, the Ethernet configuration should be set to DHCP Server or Static IP address mode. When configured with a static IP address, or when configured in DHCP Server mode, the DZMx Plus cellular data internet connection can be shared and is available via its Ethernet port.

Configure connected network devices to use the DZMx Plus IP address 192.168.4.1 as their default IP gateway.

### *DHCP Server Mode Configuration*

The DZMx Plus can be set as a DHCP server, a DHCP client, or allocated a fixed IP address.

These can be selected using DZMx Connect. Go to Settings > Preferences > Local Network > Local Network Settings.

The DZMx Plus operates as an internet router while in DHCP server mode. When a PC or laptop is plugged in using the DZMx Plus Ethernet port, the DZMx Plus DHCP server will allocate the connected device an IP address in the range 192.168.4.xxx.

**Note:** When using this mode ensure that there are no other devices on the network configured as a DHCP server.

### *Static IP Address Mode Configuration*

The DZMx Plus can be assigned static IP settings, this includes a static IP address, a subnet mask, a default gateway (optional) and Domain Name System (DNS) settings (optional).

Static IP settings (IP address, Subnet Mask) are set using DZMx Connect.

- » Go to Settings > Preferences > Local Network > Local Network Settings.
- » Select “Static IP Address” in the dropdown menu.
- » Select OK then DONE.

A static IP address may also be set using the DZMx Plus Control Head:

- » Using the keypad select MENU > Hardware Config> Wireless and Network > Static IP Configuration >press ENTER.
- » Scroll to Host IP Address, press ENTER and then specify the DZMx Plus Ethernet interface IP address e.g. 192.168.4.100, then press ENTER.
- » Scroll to Subnet Mask and then specify the subnet mask that matched the IP address (previous step) usually 255.255.255.0, then press ENTER. If the gateway IP address does not need to be configured Press END to return to the main screen.

### *Optional Gateway and DNS Configuration*

Independently from the IP address mode, DNS server settings can be specified to use a specific DNS server. This will work with all 3 possible modes (DHCP client, server, or Static IP address). This is optional as it overrides default settings provided by DHCP mode and is only required if internet connectivity is needed in static address mode.

**Default Gateway:** Specify which network gateway provides internet connectivity to the DZMx Plus. This can be an internet default gateway.

The following steps are optional.

- » Using the DZMx Plus Control Head keypad select MENU > Hardware Config > Wireless and Networks > Static IP Configuration > Gateway IP address > press ENTER.
- » To specify the default internet gateway, the DZMx Plus will where the internet connectivity is coming from a specific IP gateway (contact your cell network provider for more information) i.e. 192.168.4.100, then press ENTER. Press END to return to the main screen.
- » To override the default DNS server configuration using the DZMx Plus Control Head keypad select *Menu > Hardware Config > Wireless and Networks > DNS Configuration > DNS Server IP Address #1* > press ENTER.
- » Specify the IP address for the Primary DNS server, then press ENTER. Repeat this step for the DNS Server Address #2 to specify the Secondary DNS server IP Address. Press END to return to the main screen.

### *Applying the Specified Static IP Configuration*

To apply the specified static IP settings and optional settings, Default gateway and DNS use the DZMx Plus Control Head keypad.

- » Select MENU > Hardware Config > Wireless and Networks > Select IP Address Mode > Static IP Address > press ENTER.

This process can take a few seconds. A window advising “Ethernet configuration update please wait” will appear. Press END to return to the main screen.

**Note:** To check which IP address is in use for the Ethernet connection, using the DZMX Plus Control Head keypad: Select *Menu > Diagnostics Menu > About DZMx*. The Ethernet IP address will be displayed.

## Configure Cellular Data

To enable or disable cellular data using DZMx Connect.

- » Go to Settings > Modems > Modem 2.
- » Toggle “Enable Data” to on to allow cellular data to be used.
- » Set *Data Roaming* to allow cellular data to be used outside the area coverage of your cellular data account.
- » Set the Access Point Name (APN).

**Note:** Data roaming can incur significant charges

The APN setting must be configured to enable a data connection to be established. The APN is the name of the setting your cellular modem uses to set up a connection to the gateway between your carrier's cellular network and the public Internet. The APN you need to

specify will depend on the cellular network service provider. The APN is often published on the service provider's web site.

This setting is easier to enter using DZMx Connect as you can type in or paste in the APN. It can also be entered using the DZMx Plus Control Head.

## Enabling and Disabling Satellite Data

Modify the satellite modem settings using DZMx Connect. Select *Settings > Modem > Internal Sat Modems* to enable and disable satellite data. This cannot be enabled using the DZMx Plus Control Head keypad.

## DZMx Data Logging

The DZMx provides several data logging functions

### Flight data - see GPS Data Logging

The DZMx logs GPS data at one second intervals, including aircraft position, speed, heading and altitude, and GPS quality metrics.

### Cellular Network Data Logging

The DZMx logs network parameters for the cellular network, along with aircraft position, altitude, speed and heading. An optional speed test can also be activated, which records uplink and downlink speeds at programmed intervals.

This data can be used to review cellular network performance. Contact [tech@flightcell.com](mailto:tech@flightcell.com) for more information on analysing network performance.

- » DZMx Flight Data Recorder below for information on the flight data recorder
- » Network data - see **Error! Reference source not found. Error! Reference source not found.**
- » GPS data - see **Error! Reference source not found. Error! Reference source not found..**

The DZMx can automatically transmit log data using the DZMx Email Outbox feature.

Using DZMx Connect, go to *Settings > Preferences > Logging Email Reporting* to specify which logs are transmitted and to activate automatic emailing of the logs.

## DZMx Email Outbox

The DZMx can transmit these data logs via email. To do this, the email outbox must be configured.

Using DZMx Connect go to *Settings > Preferences > Outgoing Email Account*.

Enter the following settings: (these can be for an existing email account, or you can set up an email account):

- » Email SMTP Server.
- » Email SMTP email Login.
- » Email SMTP Password.
- » Email SMTP Port.

An example of these settings using a Gmail account for sending the data, and an in-house account as the destination is shown to the right.

Next, configure the DZMx to transmit the data:

- » Go to *Settings > Preferences > Logging Email Reporting*
- » Enter the destination email address
- » Select what data is to be emailed
- » Toggle **Logging Send Email Data Automatically** on if you want the data to be sent automatically. If selected, the DZMx will send the data for each flight when it is next powered on.

The screenshot shows a settings window titled "Preferences: Outgoing Email Account Settings". It contains the following fields and values:

- Email Smt Server: smtp.gmail.com
- Email Smt Login: myaircraftdata@gmail.com
- Email Smt Password: [masked]
- Email Smt Port (Min 0, Max 65535): 587
- Outbox validity days: 22

A "DONE" button is located at the bottom left of the settings window.

## GPS Data Logging

The DZMx logs GPS data at one second intervals, including aircraft position, speed, heading and altitude, and GPS quality metrics.

## Cellular Network Data Logging

The DZMx logs network parameters for the cellular network, along with aircraft position, altitude, speed and heading. An optional speed test can also be activated, which records uplink and downlink speeds at programmed intervals.

This data can be used to review cellular network performance. Contact [tech@flightcell.com](mailto:tech@flightcell.com) for more information on analysing network performance.

**Note:** The DZMx speed test uses a significant amount of data so should only be used when necessary to gather link bandwidth data.

## DZMx Flight Data Recorder

The DZMx has an inbuilt flight data recording function that includes an inertial measurement unit and barometric pressure sensor. The output from these sensors is logged at one second intervals.

The following raw sensor data is logged:

- » Angular rotation in all 3 axes (radians per second, relative to the DZMx).
- » Acceleration in all 3 axes (G force, relative to the DZMx).

The inertial data is fused and logged to provide:

- » Airframe pitch (degrees).
- » Airframe roll (degrees).

- » Pressure (millibars).
- » Pressure altitude (reference to 1013.25 millibars).

### Disclaimer

The Flight Data Recording system in the DZMx uses a six degree of freedom sensor fusion technique and thus all pitch and roll values output are a best estimate based on measured angular rate (prone to drift) and estimated gravity vector (which can be distorted by accelerations). This must not be used for navigational or control purposes.

### Setting up the Flight Data Recorder

The DZMx flight recorder must be calibrated for the orientation of the DZMx to provide a baseline for measures of pitch and roll.

The baseline is set based on the aircraft orientation on the ground.

The DZMx factory setting has zero offsets. To set its Mounting Offsets:

- » Install the DZMx in its final location
- » Using DZMx Connect go to *Flight > Flight Icon*
- » Note down the pitch and roll shown on the artificial horizon (AH) gauge
- » If the DZMx is installed at an angle to the longitudinal axis of the aircraft, estimate the offset in degrees
- » Click on the gear icon on the top right
- » Enter the following (in degrees)
  - Pitch recorded from the AH
  - Roll recorded from the AH
  - Estimated yaw.
- » Click *Enter* to confirm the orientation on the flight display. The AH should now show zero pitch or roll.

**Note:** If the DZMx is not aligned to any of the aircraft axes, data readings will be incorrect unless this step is performed at installation.

### Transmitting flight exceedances

The DZMx Flight Data system can detect and transmit flight exceedances:

- » Rapid ascent and descent
- » Excess G Force
- » Excess turn rate
- » Excess pitch change.

To set up transmission of flight exceedances:

- » Go to *Settings > Tracking > Flight Monitor Settings*
- » Select which exceedances to transmit
- » Set the exceedance threshold for each

**FDR Unit Orientation**

DZMx mounting offset from aircraft axes in degrees (0 -> +/-180): Yaw (right = +, left = -); Pitch (up = +, down = -); Roll (right = +, left = -)

Enter yaw offset in degrees

Enter pitch offset in degrees

Enter roll offset in degrees

CANCEL    SUBMIT



- » Enter the email address for exceedance reports
- » Select if the exceedance reports are to be sent
  - » Via email the nominated email address, and/or
  - » To your tracking service provider attached to a position report.

## Recording and Transmitting Maintenance Data

The DZMx Plus supports maintenance timers (also known as a Hobbs Meter). The DZMx Plus can record and transmit the following:

- » **TTAF** (Total Airframe Flight Time (hrs)). This records all flight time in hours and tenths of hours. The aircraft airframe hours are entered on installation, and this is incremented during every flight.

**Note:** The starting TTAF value can only be done once so it is important to set it correctly. A pin number or Hobbs password is required from Flightcell to change the flight hours after the initial set up.

- » **DFT** (Daily Flight Time) This is a continuous timer that records flight time in hours and tenths of hours. It must be manually reset and can be reset daily or reset periodically to allow the user to measure a flight or sequence of flights.
- » **Trip** (Trip time (hh:mm)) This is an hour and minute timer that resets every flight. It can also be reset mid-flight to record certain operations or flight legs.
- » **Lands** (Landings)
- » **Starts** (Engine Starts)
- » **Check Due** - to record hours since the last maintenance check and alert when the next check is due.

Maintenance data can be accessed on the DZMx Plus, and can be sent automatically to the tracking service, and emailed automatically to an address configured on the DZMx Plus.

The destination address for the maintenance data can be set in DZMx Connect. Go to *Settings > Preferences > Hobbs and Maintenance* to enter the maintenance email address and second maintenance address.

The maintenance data can be accessed on the DZMx Plus using either the:

- » DZMx Plus Control Head User Interface (UI): Go to *MENU > Timers*
- » DZMx Connect. Go to *Flight > Flight Timers*.

## Daily Flight Reporting

DFT can be manually reset either each day, or at the end of a series of flights. It is not possible to reset any timers or counters while the aircraft is in flight.

The landing and start counters are reset automatically when the DFT is reset; they cannot be reset individually.

To reset the DFT and counters

- » Using the DZMx Plus Control Head go to *MENU > Timers > DFT > Reset DFT*. Selecting **YES** will reset the DFT timer and the landing and engine start counters.

- » Using DZMx Connect go to *Flight > Flight Timers > Reset*

If a maintenance email address is specified, a maintenance email (or emails) will be sent automatically before the counters are reset.

### Check Due Counter

The DZMx Plus can record hours since the last maintenance check and advise when a check is due.

This can be configured in DZMx Connect by going to *Settings > Preferences > Hobbs and Maintenance*. Here you can set:

- » Hours till next check
- » Check due warning - hours advance warning that a check is due.

The DZMx Plus maintains an 'hours since last check' timer and subtracts it from the *Check Due* hours and displays the result as *Check Due* on the DZMx Plus Control Head *Timers* menu and/or DZMx Connect *Flight Timers* page.

The DZMx Plus will add new flight hours to the 'hours since last check' timer while in flight, resulting in the displayed *Check Due* counter decrementing when in flight.

If the hours since last check exceed the *Check Due* hours setting, then the *Check Due* will change to *Check Overdue* along with a negative value on the **Timers** menu on the DZMx Plus Control Head or on DZMx Connect.

To set the 'hours since last check' counter

- » Using the DZMx Plus Control Head, select *Check Due*, then enter the number of hours flown since the last check. Hold down the +/0 key to enter part hours to one decimal place.
- » Using DZMx Connect, go to *Flight > Flight Timer > Check Due > Set* and enter the hours since last check, then *SUBMIT*.

### Content of a Maintenance Email

The data is emailed to the tracking provider. Two email Maintenance email addresses can be nominated.

The subject line of the maintenance email will be *DZMx Plus Maintenance Report from < serial number >* and will contain the following text:

#### DZMx Maintenance Report

- Report Date: Wed, 02 Sep 2020 01:37:16 UTC
- Serial Number: E09111961

Total Airframe Hours	3650.0
Daily Flight Time	0.2
Daily Engine Starts	2
Daily Landings	3

- » The **TTAF** and daily flight timers are sent in the take-off message to the tracking provider.
- » The **TTAF, DFT, Trip, Lands** and **Starts** are sent in the landing message to the tracking provider
- » The *Trip* counter is not included in the email since this is automatically reset on every flight.

### *Maintenance Email Attached Data File*

Attached to the maintenance email will be a JSON formatted file which will contain all the maintenance data. The data in the attachment will be as follows:

```
{
  "report_type":"DZMx Plus_maintenance",
  "report_created":"Wed, 02 Sep 2020 01:37:16 UTC",
  "DZMx Plus_details":{
    "serial_number":"E09111961",
    "firmware_version":"DZMx Plus-3.5.1r799",
    "aircraft_reg":"ZK-POO"
  },
  "maintenance data":{
    "TTAF":3650.0,
    "DFT":0.2,
    "daily_engine_starts":2,
    "daily_landings":3
  }
}
```

### *Configuring the DZMx Plus for maintenance reporting*

Prerequisites:

- » The **Outgoing Email Account Settings** must be set up first for the Maintenance email to be transmitted,
- » **Tracking** must be enabled and either a take-off or a take-off speed must be configured for Hobbs and maintenance email data to be included in landing and take-off messages,
- » An **Oil Pressure Input** must be configured for engine starts to be counted and visible in the **Timer** page,
- » A **Take-Off Input** or a **Take-Off Speed** must be configured for landings to be counted and visible on the **Timer** page.
- » The **Maintenance Email Address** and/or 2nd Maintenance Address must be set for a maintenance email to be sent. To setup using DZMx Connect go to **Settings > Preferences > Hobbs and Maintenance**
- » The **Check Due Hours** setting must be set and the **Check Due Warning Hours** must be set to see a check due warning pop-up message.

### *Configuring Maintenance Data Using DZMx Connect*

Maintenance data to be sent can be selected by both the Installer and the Operator using DZMx Connect. The maintenance email is sent automatically when the daily timers are reset.

Using DZMx Connect go to *Settings > Preferences > Hobbs and Maintenance* to modify the following settings:

- » **Count Engine Starts:** (This can be toggled on/off)
- » **Count Landings:** (This can be toggled on/off)
- » **Check Due Hours** (Min 1, Max 10000): Enter the Flight Hours.
- » **Check Due Warning Hrs** (Min 0, Max 10): Adjust using the scroll bar or type in the number of hours.
- » **Send in Tracking Msg:** (This can be toggled on/off) If this is toggled off none of the counters or timers will appear in the landing message sent to the tracking provider.
- » **Maintenance Email Address:** This can be a different email address to what was set up in the DZMx Plus Outbox.
- » **2nd Email Address:** This is an additional email setting to allow for a second maintenance email to be sent.

## Forms

Forms is a feature developed to aid operators to collect data and analyse flight trends. Forms can be used to enter and report operational data. Data can be entered into forms on the DZMx Plus keypad or on DZMx Connect.

Form design and modification requires installer privileges. Only New Data and View Data options are visible to Operators.

Forms are created and configured using DZMx Connect.

## Manage Forms Using DZMx Connect

### *To Create a Form*

Up to 25 user-defined form templates can be created. A maximum of 50 recorded data entry lines can be recorded in this file. Older ones will drop off the end and are not written to the file.

To create a form on DZMx Connect, go to *Forms*, click on the “+” icon, and enter a name for the form. Click *SUBMIT* to create the form template.

*Note:* The form name is limited to 25 characters.

The *General* page provides the following prompt options:

- » Transmission Options
  - » *Include Position* - Toggle On or Off. Includes speed and altitude when sent.
  - » Report to Tracking Provider - Toggle On or Off
  - » *Email Address* - data can be sent to an email address via cellular
- » Form Triggers
  - » Form prompt - options are No Prompt, On Start-up, On Landing and Flight Timer.
  - » Flight Time prompted forms will prompt after the given number of hours specified from when the form was enabled. After a Flight Time prompted form has been filled in, the next prompt will occur at the number of hours specified since the prompt trigger time (i.e. not the time since the form was filled in).

The *Fields* page is used to create data entry fields in the form:

- » Select the “+” symbol.
- » A *Form Editor* window will open.
- » Enter a unique *Field Name* > select whether the form must be completed (*Mandatory*) or does not have to be completed (*Optional*). If Mandatory is selected the form cannot be completed unless all the mandatory fields are filled in.
- » Type: Select the response e.g. *On/Off, Yes/No, Number or Text*. Note: The *Number* and *Text* fields have a maximum length of 25 characters.

#### *Enter, view, edit or delete data*

Go to *FORMS > Available Forms*. Select the required form.

Sliding left will expose the following options:

- » **New Data** - This option will only be available if the form has been enabled and allows the user to fill in a form entry.
- » **View Data** - shows any form data
- » **Edit** - Edit the form template
- » **Delete** - Removes the template and any associated data.

#### *To view, export or delete data*

- » Go to View Data.
- » A specific entry can be viewed in detail by clicking on it.
- » The complete form data can be downloaded using the download button  located at the top right of the title bar. Data is downloaded to the downloads file on a PC, or to a selected destination on a smart device.
- » The form data can be deleted using the delete button located at the top right of the title bar.

#### *Enable/Disable specific form(s)*

The tick box  to the left of the form name allows the installer to enable/disable the form. A tick indicates the form is enabled.

Disabling a form will cancel any active trigger on that form. It will also cause the flight hours to reset to 0 for that form if the trigger type is set to Flight Time. Flight time will only start to accrue for the form when it is re-enabled.

## **Forms DZMx Plus Interface**

This section describes what forms application functions are available and configurable using the DZMx Plus Control Head menu.

### *The Forms List*

To see which forms are available select *MENU > Forms*

If there are no form templates *Timers* will be the top item and *Forms* will not appear in the menu list.

### Enabled and Disabled Forms

By default, the forms list will show only enabled forms. If there are any forms disabled a menu option *Show All Forms* will be displayed. Select *Show All Forms* to view the disabled forms in the list.

### Forms List Tags

Forms in the forms list are prefixed with a character.

- » *Disabled Tag*: Forms in the forms list prefixed with - (minus) character are disabled forms. An operator cannot fill in a disabled form and disabled forms will never be triggered. A disabled form can be enabled by an Operator and an installer. Select the form by pressing *ENTER* > *Form Enabled* > Confirm by selecting either *No* or *Yes*
- » *Triggered Tag*: Forms in the forms list prefixed with a \*(asterisk) character have been triggered and the tag indicates that the form is due to be filled in. The tag will disappear once the form has been completed.

### Filling a Form

- » Go to *MENU* > *Forms*. The number of forms in the list is displayed at the top of the screen.
- » Enabled forms in the *Forms* list display the name of the *Form Field*. If data is already entered the entered value will appear to the right of the Form Field name.
- » If a form has been triggered by an event (e.g. start-up or flight time), the DZMx Plus will beep and display the *Form Field* list. The name of the triggered form be highlighted and appear at the top of the list. Press *ENTER* to access the field entry screen.
- » The field entry screen options are:
  - » No/Yes
  - » On/Off
  - » **Number**: Use the keypad to enter the number.
  - » **Text field**: Select the *DOWN* key. The number 9 will appear on the screen. Use the ▲ key to scroll through the alphabet. Select the first letter, use the ► key to enter the next letter followed by the ▲ key to scroll through the alphabet. Repeat to complete the text. Select *ENTER* to complete the field entry.
- » At the bottom of the form fields, Select *Form Complete* to save the entry. The form will transmit to the email destinations as per the template settings.
- » The screen will return to the list of forms and the cursor will highlight the next form in the list to be completed.
- » If any mandatory fields have not been filled in a warning will pop up; *Form Entry Required*: <field name > and then the form entry cursor will be moved to the required field.

### Incomplete Forms

If a form has not been completed the data entered will remain and can be completed later. If however the unit is powered off the data will be lost.

### Form Entry Required

It is not possible to complete a form if any mandatory fields have not been filled in.

- » To remind the operator to complete the form(s) *Form Entry Required* will appear across the top line of the main screen
- » Use the *MODE* key to access the triggered forms. Pressing the *MODE* key will cycle through each triggered form.
- » Complete each form then select the *MODE* key again to exit to the main menu screen.
- » If the DZMx Plus is powered off before an actively prompted form has been completed the form will appear on the screen when the DZMx Plus is next powered on.

### Clear Form

To remove data from a *Form Entry* field prior to selecting *Form Complete*.

- » Select *MENU* while on the *Form Entry* screen.
- » Press *ENTER* > *Clear Form* > *ENTER*.
- » “*Form Fields Cleared*” will appear on the screen.
- » The DZMx Plus will not display a *Yes/No* confirm option.
- » Press *END* to return to the Main menu.

### Form List Sub-menu

To access the Forms sub menu go to *MENU* > *Forms* > (name of form) > *MENU* .

The following form editing options are available in the sub menu:

Sub Menu	Operator	Installer
Form Configuration	x	x
Form Enabled	x	x
Export Form History	x	x
Delete Form History		x

### Form Configuration

Selecting *Form Configuration* will show the following settings (This is a view only screen, the displayed information cannot be edited):

- » Report to Track Provider: Yes/No
- » Email: <email address >
- » Include Position: Yes/No
- » Prompt Trigger: <trigger type > e.g. On Landing

### Form Enabled

Select *Form Enabled* > *Confirm* by selecting either *No* or *Yes*

**Note:** Disabling a form will cancel any active trigger on that form. It will also cause the flight hours to reset to 0 for that form. If the trigger type is set to Flight Time. Flight time will only start to accrue for the form when it is re-enabled.

#### *Export Form History*

Exports the data for the selected form to a USB stick. If no USB stick is inserted or if there is no data to export a *Form error USB error* message will appear.

#### *Delete Form History*

All data records that have been recorded for the selected form can be deleted.

Select *Delete Form History* > Confirm by selecting either *No* or *Yes*.



## Section 7: DZMx Plus Applications

Flightcell has developed specialised applications on the DZMx Plus to support specific types of operation.

### DZMx Plus Applications and Licences

Some DZMx Plus applications require a licence to be activated. If the licence has been purchased with the DZMx Plus, then the application will be activated before delivery. If the licence is required after delivery of the DZMx Plus, the application licences can be installed using DZMx Connect.

To purchase an application licence, contact Flightcell at [info@flightcell.com](mailto:info@flightcell.com). We will send you a licence file.

To load the licence file:

- » Open DZMx Connect and enter the installer password.
- » Go to *About*, this will show a list of licences currently installed on the DZMx Plus.
- » Click on **UPLOAD LICENSE** and follow the prompts.
- » Restart the DZMx Plus.

### DZMx Plus Applications

These following licensed applications are described in this manual:

- » DZMx Plus Wi-Fi - this application activates the Wi-Fi and Bluetooth services on the DZMx Plus.
- » DZMx Plus Bluetooth - this application activates only the Bluetooth service on the DZMx Plus.
- » Iridium Push-To-Talk Ir(PTT).
- » Iridium Certus.

For information on the following applications, contact Flightcell International at [info@flightcell.com](mailto:info@flightcell.com)

- » Firefighting application.
- » Dropbox file transfer application.
- » SBD mailbox application.
- » Airline application.
- » Agriculture application.
- » Loadcell application.

# Section 8: Maintenance, Diagnostics and Support

## Firmware Upgrades

Flightcell regularly releases firmware upgrades to provide new features, enhancements to existing features and bug fixes.

The duration of the upgrade will vary and is dependent on the previous firmware version installed. It will take between 5 and 40 minutes to complete.

The DZMx Plus must remain connected to a power supply at all times.

A firmware upgrade can be carried out in two ways:

- » Using DZMx Plus USB port upgrade method.
- » Using DZMx Connect upgrade method.

If using the USB upgrade method, download the firmware directly from [www.flightcell.com/support/firmware](http://www.flightcell.com/support/firmware) and save it to a USB memory stick.

If using DZMx Connect upgrade method, download the firmware directly from [www.flightcell.com/support/firmware](http://www.flightcell.com/support/firmware) and save it to the PC or laptop hard drive.

Ensure the aircraft is on ground power or there is enough battery power to run the DZMx Plus for at least 1 hour (DZMx Plus draws approximately 1A at 28VDC).

To perform the upgrade:

### *Using the DZMx Plus USB port:*

- » Insert the USB memory stick into the DZMx Plus USB port.
- » On the DZMx Plus Control Head go to *MENU > Hardware Config > press ENTER*.
- » If necessary, enable the DZMx Plus extended menus using *Installer Menu Enable*, enter the installer password, then press *ENTER*.
- » Scroll down to *Firmware Upgrade* and press *ENTER*. The upgrade will commence.
- » Follow the prompts on the DZMx Plus Control Head display.

### *Using DZMx Connect:*

- » Open DZMx Plus on a connected laptop or PC
- » Go to *About*
- » Select *Upgrade* and browse to the saved firmware file.
- » Select *Upload* and wait for the firmware file to upload to the DZMx Plus. Once the file has been fully uploaded the upgrade process will start automatically. The display and keyboard may alternatively flash on and off during this period, and the DZMx Plus will reboot.
- » When the DZMx Plus has rebooted, on the DZMx Plus Control Head go to *MENU > Diagnostics Menu > About DZMx Plus*, press *ENTER*. Check that the new firmware version is displayed.

## Diagnostics

The DZMx Plus provides a range of diagnostic and other information on various aspects of the system.

### Real-Time Diagnostics

The DZMx Plus diagnostic pages may enable you to resolve any configuration or other issues.

The following options in the *Diagnostics Menu* may be available:

About DZMx Plus	Contains the DZMx Plus serial number, firmware version, IP address, memory usage and whether a USB device is mounted.
System Information	Contains the serial numbers for the fitted cards
GPS Diagnostics	Contains information on the GPS connection
Sat Device Details	Contains information on the IMEI and network status of the satellite device
Cell Modem Details	Contains information on the IMEI of the cellular device, and on the status and band used by the cellular modem
Cell Modem Data	Contains information on the cell data connection
Ext Modem Details	Contains information on an external modem or phone in a cradle
Tracking over IP	Contains diagnostic information on the tracking over IP function. Performs a check on the settings used to enable Tracking over IP as well as a real time test using the configured tracking provider gateway
Local Network Info	Contains diagnostics on the status of the Bluetooth and Wi-Fi connections
External Inputs	Contains diagnostics on the current status of the DZMx Plus General Purpose Inputs
Export System Log Files	Exports system log files for diagnostics and support

### Exporting Diagnostic Log Files

The DZMx Plus maintains diagnostic log files, capturing key information on system performance. This information can be exported to a memory stick installed in the DZMx Plus USB port.

To export log files to a memory stick:

- » Install a USB memory stick in the DZMx Plus USB port
- » On the DZMx Plus Control Head, go to *MENU > Diagnostic Menu > Export System Log Files*. When the download is completed press *END* to return to the main screen.
- » Remove the memory stick and extract the files on a PC.
- » Logfiles can also be downloaded in DZMx Connect.
- » Go to *About*, click on the signal strength bars on the top right.

- » Click on *Device Logs > Download all*. A zip file containing the logfiles will be downloaded to your default download folder.

**Note:** These files are not user-readable. They should be forwarded to Flightcell International with a description of any problems.

## Flightcell Remote Assistance

Flightcell Remote Assistance Virtual Private Network (VPN) allows Flightcell support staff to remotely connect to a DZMx Plus and help with diagnostics, using a secure encrypted connection. This requires either a cellular data connection or a wired Ethernet connection.

### Initial Remote Assistance Setup

Remote Assistance must be set up on the DZMx Plus before it can be used. This is a one-off configuration step and will never need to be repeated.

To set up a connection, request a password from Flightcell International Support ([tech@flightcell.com](mailto:tech@flightcell.com)). You will need to provide the serial number of the DZMx Plus.

- » Using the DZMx Plus Control Head keypad go to MENU > Remote Assistance > Setup Connection or
- » Using DZMx Connect go to *Remote Access*.
- » Enter the password provided by Flightcell and press **ENTER**

If the setup was successful a *Configuration received ok* message will be displayed.

**Note:** If the DZMx connection has been set up previously, the **Setup a Connection** option will not be displayed and instead you will have three menu options: **Connect VPN**, **Reset Connection** and **Enable at Start up**. In this instance go direct to step 2 "Establish a VPN Connection".

### Establishing a VPN Connection

This provides a secure connection between the DZMx Plus and Flightcell support team. The support staff will receive a notification and they will be able to remotely access the DZMx Plus.

The DZMx Plus will operate normally throughout this process.

To establish a VPN connection:

- » Using the DZMx Plus Control Head keypad go to *MENU > Remote Assistance > Connect VPN*, then press *ENTER* or
- » Using DZMx Connect select *Remote Access* and toggle *Connect* to **ON**.

If the connection is successful a "*VPN connection online*" message will be displayed.

If the connection is unsuccessful an "*Error: VPN connection has failed*" message will be displayed.

**Note:** An unsuccessful connection can occur when a data connection is unreliable, or the remote assistance server is unreachable.

## Disconnect a VPN Connection

You can disconnect a VPN at any time. Disconnection would normally be done once Flightcell support has finished assisting and has given the 'all-clear'. The VPN connection can be disconnected on the DZMx Plus Control Head or on DZMx Connect.

Once the OpenVPN settings are configured and saved, the VPN connection status can be accessed both from DZMx Connect and from the DZMx Plus Control Head screen configuration Menu.

## Other Menu Options

### *Reset Connection*

This menu option resets and updates the Remote Assistance connection and you will typically be directed to do this by Flightcell Support.

### *Enable at Start-up*

This menu option forces the DZMx Plus to automatically establish a VPN Remote Assistance connection on start-up. This feature is useful for long-term monitoring and diagnosis.

## Section 9: Documentation and Information

Comprehensive documentation for the DZMx Plus is available on the Flightcell website <http://www.flightcell.com>.

Documentation, user instructions and technical information can be ordered by contacting Flightcell.

### Contact Details

#### Mailing Address

Flightcell International Limited  
PO Box 1481  
Nelson 7040 New Zealand

#### Physical Address

Flightcell International Limited  
98 Vickerman Street  
Nelson 7010 New Zealand

<b>Telephone</b>	+64 3 545 8651
<b>Fax</b>	+64 3 548 8091
<b>Email</b>	<a href="mailto:info@flightcell.com">info@flightcell.com</a>
<b>Website</b>	<a href="http://www.flightcell.com">http://www.flightcell.com</a>

## Section 10: Warranty

Flightcell International Limited's quality products are proudly designed and manufactured to the highest standards in New Zealand. Your DZMx Plus is warranted for one year from date of sale. Your warranty can be extended to five years if you have purchased the extended warranty and your DZMx Plus is registered on our product registration system. To register your product, go to [www.flightcell.com/support](http://www.flightcell.com/support).

The DZMx Plus warranty covers Flightcell manufactured items only. Any ancillary items may be covered by individual manufacturer warranties.

The warranty is void if any labels are removed or if it is determined that your DZMx Plus has been:

- » Connected to a power supply delivering more than 32 Volts
- » Connected with reverse polarity
- » Installed in direct contravention to the guidelines outlined in the Flightcell DZMx Plus Installation and Configuration Manual
- » Physically damaged, or a fault has occurred due to the product being used beyond what is considered normal use, causing unusual deterioration of the product.

If the product is deemed to be faulty or in need of repair, please complete a Returned Materials Authorization form on [www.flightcell.com/support](http://www.flightcell.com/support) or contact Flightcell International.

If the DZMx Plus is deemed to be faulty or in need of repair, please complete a Returned Materials Authorization form on [www.Flightcell.com/RMA](http://www.Flightcell.com/RMA) or contact Flightcell International [info@flightcell.com](mailto:info@flightcell.com).

## Section 11: Abbreviations

Abbreviation	Definition
A.R.M	Automated Rescue Monitoring
A2DP	Advanced Audio Distribution Profile
AFF	Automated Flight Following
AIS	Automatic Identification System
API	Application Programming Interface
AWTC	Automatic Water Tank Controller
Calib	Calibration
Config	Configuration
DFT	Daily Flight Timer
DTMF	Dual Tone Multiple Frequency
EMER	Emergency
Ext	External
GPS	Global Positioning System
HD Tracking	High-Definition Tracking
HFP	Hands Free
ICS	Internet Connection Sharing
IP	Internet Protocol address
IRPTT	Iridium Push to Talk
LCD	Liquid Quartz Display
NOTAM	Notices to Airmen
PTT	Push to Talk (radio/ICS)
SATCOM	Satellite Communication
SBD	Iridium Short Burst Data
SIM	Subscriber Identity Module
SMS	Short Message Service
TTAF	Total Time Airframe Hours
VoIP	Voice over Internet protocol
VPN	Virtual Private Network



# Appendix 1. Connector kits supplied with DZMx Plus and associated parts

## DZMx Plus

Description	Supplied with	Component Description	Qty/ Kit
CNP_00049 - Flightcell DZMx Plus Connector Kit	Flightcell DZMx Plus Install	112116 - BNC Straight Crimp Plug, RG58	1
		122108 - TNC Straight Crimp Plug, RG58	3
		132113 - SMA Straight Crimp plug, RG58	5
		8655MH3701BLF - Metal Back Shell for DD Size connectors Straight (62 way)	1
		M24308/2-14F - DD62S M24308 Crimp and Poke Socket with Contacts (Female)	1
		5-1478762-2 - Metal Backshell for DA Size connectors Straight (15 way)	1
		M24308/2-2F - DA15S M24308 Crimp and Poke Socket with Contacts (Female)	1

Description	Supplied with	Component Description	Qty/ Kit
CNP_00047 - Flightcell DZMx Plus Skyconnect Tray Connector Kit	Flightcell DZMx Plus Skyconnect Tray Install	112116 - BNC Straight Crimp Plug, RG58	1
		122108 - TNC Straight Crimp Plug, RG58	3
		132113 - SMA Straight Crimp plug, RG58	5
		5-1478762-3 - Metal Back Shell for DB Size connectors Straight (25 way)	2
		5-1478762-2 Metal Backshell for DA Size connectors Straight (15 way)	1
		M24308/2-2F DA15S M24308 Crimp and Poke Socket with Contacts (Female)	1
		M24308/4-3F DB25P M24308 Crimp and Poke Plug with Contacts (Male)	2
		8655MH3701BLF - Metal Back Shell for DD Size connectors Straight (62 way)	2
		M24308/2-14F - DD62S M24308 Crimp and Poke Socket with Contacts (Female)	1

		M24308/4-14F - DD62P M24308 Crimp and Poke Plug with Contacts (Male)	1
		160-000-006R032 - Dsub 4-40 Female Coupling Nut 6.35mm	6

**Connector kits for associated parts installed with DZMx Plus**

Description	Supplied with	Component Description	Qty/Kit
CNP_00030 Flightcell DZMx Remote Head Connector Kit	Flightcell DZMx Remote Head	5-1478762-2 Metal Backshell for DA Size connectors Straight (15 way)	1
		M24308/2-2F DA15S M24308 Crimp and Poke Socket with Contacts (Female)	1
CNP_00004 - Flightcell Cradle D25 Connector Kit	Flightcell Iridium Phone Cradle	122108 - TNC crimp plug, RG58	1
		M24308/2-3F - DB25S M24308 Crimp and Poke Socket with Contacts (Female)	1
		5-1478762-3 - Metal Back Shell for DB Size connectors Straight (25 way)	1
CNP_00005 - Dual Antenna BNC/TNC Connector Kit	Dual Iridium/GPS antennas	112182 - BNC Plug R/A 50 OHM Crimp	1
		122150 - TNC Plug R/A 50 OHM Crimp	1
CNP_00029 - Single Antenna TNC Connector Kit	Single Iridium/CELL antennas	122150 - TNC Plug R/A 50 OHM Crimp	1
CNP_00042 - Dual Antenna TNC Connector Kit	Dual Iridium/CELL antennas	122150 - TNC Plug R/A 50 OHM Crimp	2
CNP_00039 - Flightcell Iridium Modem Connector Kit	Flightcell Iridium modem	M24308/4-2F - DA15P M24308 Crimp and Poke Plug with Contacts (Male)	1
		5-1478762-2 - Metal Backshell for DA Size connectors Straight (15 way)	1
		122108 - TNC Straight Crimp Plug, RG58	1

# Appendix 2. Advanced routing functions

## Configuring advanced routing

Where the DZMx has more than one data-capable modem (e.g. two cell modems and/or a Certus modem), the DZMx advanced routing provides for improved data connections and automatic failover when moving in and out of network coverage. For example, the DZMx can switch its data from a preferred cellular network to a second network depending on network coverage, and switch to Certus satellite data when outside cellular coverage.

### *Configuring preferred gateway and automatic fail over*

The DZMx supports an advanced internet monitor and routing interface to allow a user to configure their preferred gateway (cellular or satellite) and select a policy for automatic failover. The system is based around two components:

- » Network Monitor - this system runs periodically on each internet connected interface using a logical OR of three methods to establish if that gateway has internet connectivity (ping, DNS request and http request).
- » The network monitor can also be used to run an automated speed-test periodically. This is only run on cellular interfaces to avoid high satcom costs. The speed-test is disabled by default.  
*Note: the ping can be disabled from the connectivity test if required.*
- » Routing Manager - this system also runs periodically. It uses the output of the internet monitor and the selected routing policy to determine the best interface to use for internet connectivity.

Both components can be enabled and disabled. When either or both is/are disabled, the DZMx will use a default static cellular configuration without automatic failover.

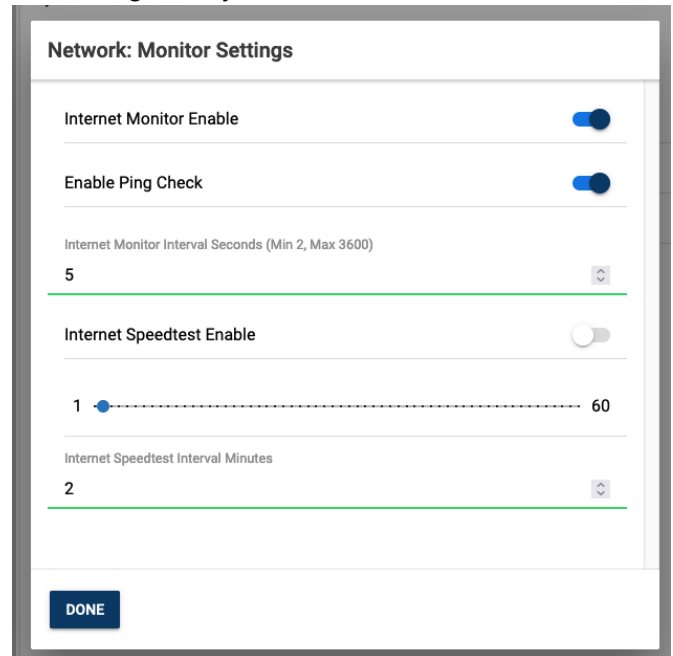

## Network Routing Settings

Network routing is configured in Settings>Network Routing.:

The automated routing options available are as follows:

- » Cellular only -satcom interfaces are ignored
- » Satcom only - all cellular interfaces are ignored
- » Prefer cellular - always use cellular when available otherwise use satcom
- » Prefer satcom - always use satcom when available otherwise use cellular
- » Least cost - same as cellular.

Additionally, when two cell modems are installed, the preferred interface may be selected:

- » Auto
- » Slot 4
- » Slot 5

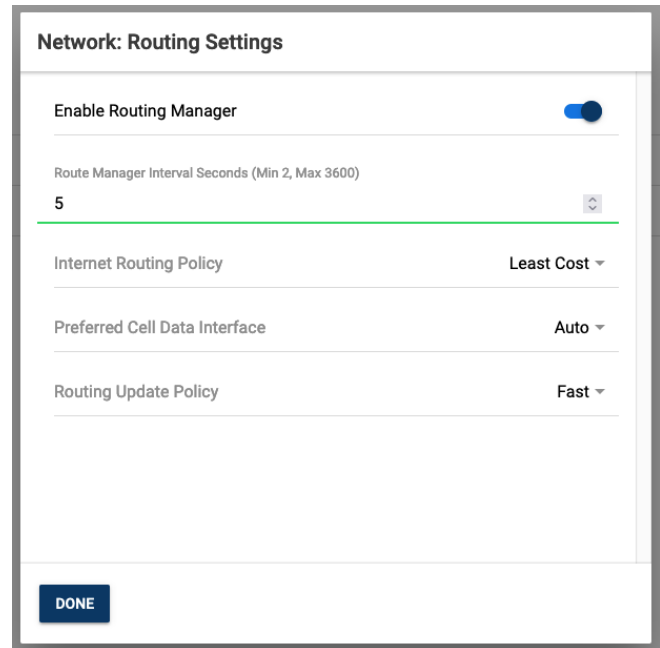

## Connectivity & Diagnostics

Once enabled, the DZMx will use the available data connections in accordance with the routing policy set on the device. In the most common scenarios, the Satcom data connection will be used only when lower-cost cellular interfaces are unavailable.

The active route is shown by an icon  on the DZMx display

The online connection status can be obtained on the *About > Diagnostics > Link Statistics*, in the Online Connectivity page on DZMx Connect. If the terminal is connected to the primary ethernet, the *eth0* row is the relevant row. If the terminal is connected to the secondary ethernet, the *eth1* row is the relevant row.

The currently used connection is identified in the first row of the Routes table.

**Note:** The diagnostics page is accessed via the icon at the top right of the About page .

Menu ONLINE LOGIN  ← Diagnostics

Locate

Discover

Navigate

- Contacts
- SMS
- Dialler
- Inbox
- Flight
- Forms

Settings

- Audio Manager
- Connectivity
- Remote Access
- Settings
- Quick Messages
- Inputs
- About

▼ Link Statistics

Uptime

DZMx Time(UTC)	DZMx Up Time	Local Time
Wed 05 Jul 01:55:25	3h30m25s	Wed Jul 05 2023 13:55:24 GMT+1200 (New Zealand Standard Time)

Interfaces

Name	Desc.	Subnet	Supnet
eth0	Ethernet	192.168.30.254/32	192.168.30.46
wlan0	(Unknown)	192.168.2.0/24	192.168.2.1
eth1	(Unknown)	192.168.10.0/24	192.168.10.52
wwans5_raw	Modem 2 - Cell	100.95.112.116/30	100.95.112.118

Traffic

Name	Packets		Errors		Dropped	
	Tx	Rx	Tx	Rx	Tx	Rx
eth0	81529	156809	0	0	0	6319
wlan0	5151	4480	0	0	0	2
eth1	246143	178953	0	0	0	0
wwans5_raw	81811	70467	0	0	0	0

Online Connectivity

Interface	Online	DNS	HTTP	Ping
eth0	true	true	true	false
eth1	false	false	false	false
wwans5_raw	true	true	true	false

Routes

Destination	Next Hop	Subnet Mask	Metric	Egress Interface
0.0.0.0	100.95.112.117	0.0.0.0	112	wwans5_raw
0.0.0.0	192.168.10.1	0.0.0.0	202	eth1
100.95.112.116	0.0.0.0	255.255.255.252	0	wwans5_raw
192.168.2.0	0.0.0.0	255.255.255.0	0	wlan0
192.168.10.0	0.0.0.0	255.255.255.0	0	eth1
192.168.30.0	0.0.0.0	255.255.255.0	0	eth0
192.168.30.254	0.0.0.0	255.255.255.255	1024	eth0

- ▶ Cellular Signal
- ▶ Cellular Data Logs
- ▶ Device Logs

### Network Monitor API endpoints

Two non-authenticated HTTP endpoints exist to let an external agent query the internet and interface connectivity status:

<http://<ipaddress>:8080/datamanager/api/internetstatus/>

This endpoint shows the current global connectivity and interface in use. The json response is shown below.

```
{
  "dns_ok": true,
  "http_ok": true,
  "ping_ok": false,
  "online": true,
  "timestamp": "2023-09-07T00:15:46Z",
  "interface": "Generic",
  "defaultRoute": {
    "nexthop": "192.168.30.254",
    "metric": "200",
    "name": "eth0",
    "destination": "0.0.0.0",
    "mask": "0.0.0.0"
  }
}
```

<http://<ipaddress>:8080/datamanager/api/interfacestatus/>

This endpoint shows the connectivity status of all available gateway interfaces. The json

response is shown below.

```
[
{
  "timestamp": 1694045994,
  "interface": "eth0",
  "online": true,
  "http_ok": true,
  "dns_ok": true,
  "ping_ok": false,
  "latency": -1
},
{
  "timestamp": 1694045994,
  "interface": "wwans5_raw",
  "online": true,
  "http_ok": true,
  "dns_ok": true,
  "ping_ok": true,
  "latency": 320
}
]
```

# Appendix 3. Configuration of Iridium Certus service

The DZMx can support an externally connected Certus Satellite terminal, providing:

- » Data connectivity
- » Voice services.

Currently, only the Guardian G6 and G6S Certus modems are supported, but further Certus options may be supported in future.

The G6 and G6S provide an IP data connection at 88kbps uplink and downlink.

## Certus License and Application Activation

In order to use Certus, the DZMx must be connected via ethernet to the G6 and have the appropriate Certus license.

Once licensed, the Certus G6 administration interface can be accessed at <http://192.168.10.1>.

Data connectivity and voice services can be managed through the DZMx Connect Application and the DZMx front panel user interface.

## Network Settings

For the correct operation of a connected Certus G6 terminal, the following network configuration can be used. This document assumes that the primary DZMx ethernet port (designated Eth0) is used for other locally networked devices, with the secondary (Eth1) port used for the Certus G6 terminal. If only a single ethernet port is available, the secondary port settings shown below should be used on Eth 0.

Primary Port Settings (Settings > Network > Ethernet Settings)

Setting	Suggested Value
Ethernet Configuration	DHCP Server
Eth0 Host IP Address	192.168.4.1
Eth0 Subnet Mask	255.255.255.0
Eth0 Gateway Address	192.168.30.254
Eth0 DNS Server #1	8.8.8.8
Eth0 DNS Server #2	
DZMx Eth Nat Interface	On

Secondary Port Settings (Settings > Network > Ethernet Settings)

Setting	Suggested Value
Secondary Ethernet Configuration	DHCP Server
Eth1 Host IP Address	192.168.10.52
Eth1 Subnet Mask	255.255.255.0
Eth1 Gateway Address	192.168.10.1
Eth1 DNS Server #1	8.8.8.8

Eth1 DNS Server #2	
DZMx Eth1 Nat Interface	On

## Certus Settings

The Certus settings available in DZMx Connect are split into General Settings and G6 Specific Settings.

### *Certus General Settings*

Go to Settings > Certus > General Settings.

Setting	Suggested Value
Certus Terminal Type	G6 or G6S (Certus 100)
Use For Voice	On: activates voice services
Call Audio Priority	3rd priority
Use For Tracking	Off: Transmission of tracking data over Certus is not currently implemented
Enable Data	On: Allow system to use Certus as an active data connection according to advanced routing rules

### *Settings for G6 and G6S*

Go to Settings > Certus > G6 Settings.

Setting	Suggested Default Value
G6 IP Address	192.168.10.1
G6 MQTT Port	8001
G6 API user	admin
G6 API Password	See G6 documentation
SIP Server Address	192.168.10.1
SIP User	user1 or user2
SIP Password	See G6 documentation

**Note:** The Certus G6 uses a VOIP system to provide the voice calling interface via the DZMx. This relies on a SIP server on the G6 system. To ensure voice calling is possible, the SIP settings must be correct in accordance with the G6 documentation.



## Connectivity & Diagnostics

### *Data Connectivity*

The Certus terminal data is enabled via the setting shown in the previous section. Once enabled, the DZMx will use the G6 data connection in accordance with the routing policy set on the DZMx. (*Settings > Network > Monitor & Settings > Network > Routing*). In the most common scenarios, the Satcom (Certus) data connection will be used only when lower-cost cellular interfaces are unavailable. Other routing options allow for Satcom (Certus) only, Cellular only or preferred interface connections.

The online connection status is shown in *About > Diagnostics > Link Statistics*, in the Online Connectivity section. If the terminal is connected to the primary ethernet, the *eth0* row is the relevant row. If the terminal is connected to the secondary ethernet, the *eth1* row is the relevant row.

The currently used connection is identified in the first row of the Routes table.

**Note:** The diagnostics page is accessed via the icon at the top right of the About page

### *Certus G6 Terminal Status*

The terminal status can be found in *About > Diagnostics > Certus*

### *Diagnostic Information*

Some diagnostic information relating to the Certus terminal may be found by accessing the DZMx diagnostics at *Menu > Diagnostics Menu > Certus Device Details*.

### *DZMx Connect Web Interface*

The diagnostic and system status available through DZMx Connect is described in the previous Data & Connectivity section.

## Dialing, Answering and Terminating Calls

Calls can be dialed, answered or terminated on the DZMx keypad and display, or on DZMx Connect. Call management can be accessed through the dialer page of DZMx Connect.

The Certus terminal will appear as a separate dialer interface at the bottom of the page.